

 **KINDRED**



2024 COLLECTION





Contents

BROOKMORE	10
Undermount Collection	12
Topmount / Drop In Collection	20
ADA Collection	28
STEEL QUEEN	30
Undermount Collection	32
Topmount / Drop In Collection	40
Utility Collection	48
CREEMORE	58
Topmount / Drop In Collection	60
REGINOX	66
Undermount Collection	68
Topmount / Drop In Collection	74
ADA Collection	78
URBAN GRANITE	82
Undermount Collection	84
Topmount / Drop In Collection	88
WASTE DISPOSERS	92
SINK ACCESSORIES	96



Highlights

New Slate Grey Granite Finish

Slate Grey, a rich, matte finish with earthy undertones, strikes a harmonious balance between elegance and versatility. Its deep, dark finish effortlessly pairs with classic whites, soft beiges, and natural wood accents while also serving as an excellent complement for contemporary designs seeking a hint of warmth.

See our full Urban granite collection starting on page 82.

Brookmore ADA Collection

At Kindred, we're committed to delivering functional designs that adapt to your unique needs while maintaining the highest standards of quality and style. We designed our Brookmore ADA sinks with your comfort and convenience in mind. These versatile dual mount sinks, which feature an easy-to-clean finish, shallow bowl depth, and rear drain placement, are perfect for users of all ages and life stages.

Visit page 28 for more details.





The Kindred Crown

A symbol of engineering excellence. The Kindred Crown reflects our passion for making your kitchen the happiest room in your home.

Our crown signifies our commitment for creating exceptional sinks that offer the reliability and durability your kitchen needs. So go ahead, host your most memorable Sunday brunches, bake your sweetest desserts, celebrate your family's greatest milestones, and tackle all the deliciously messy moments in between with confidence and ease.

It's the mark of excellence in sinks and the emblem of ease in the kitchen. Backed by a long history of making life's messy moments easier while integrating innovative design and artistry. The Kindred Crown epitomizes sinks made for real life in your home.

Give your kitchen the Kindred Crown it deserves.





Made to Work

At Kindred, we put the Crowning touch on sinks that are made for real life. With a wide range of styles and sizes, Kindred offers versatile, reliable products built for hard work and made to last.

From stainless steel to natural granite, we have the perfect sink to suit any interior style. Whether you prefer the seamless look of an undermount or the classic charm of a drop in, Kindred has you covered.

With our extensive range of bowl configurations, you can integrate our quality sinks into any space in your home. From the kitchen to the laundry room, from the mud room to the bar, wherever you require a quality sink, Kindred has the solution.

Whether you're outfitting a farmhouse retreat or completing a contemporary chef's kitchen, our thoughtful designs and durable engineering ensure our products are made to work.



Made to Last

The kitchen is the heart of the home — and the sink is the heart of the kitchen.

Kindred has spent decades fine-tuning our tried and true sink designs to ensure our heartbeat only gets stronger with each passing year. You'll fall hard for their beauty and reliability, which will continue to shine thanks to our durable finishes.

Other features to make your relationship with Kindred ideal: our easy-to-clean stainless steel, our sound absorbing systems, and our drain systems — all guaranteed to maximize long-term enjoyment.

It's clear that Kindred sinks are **made to last**.

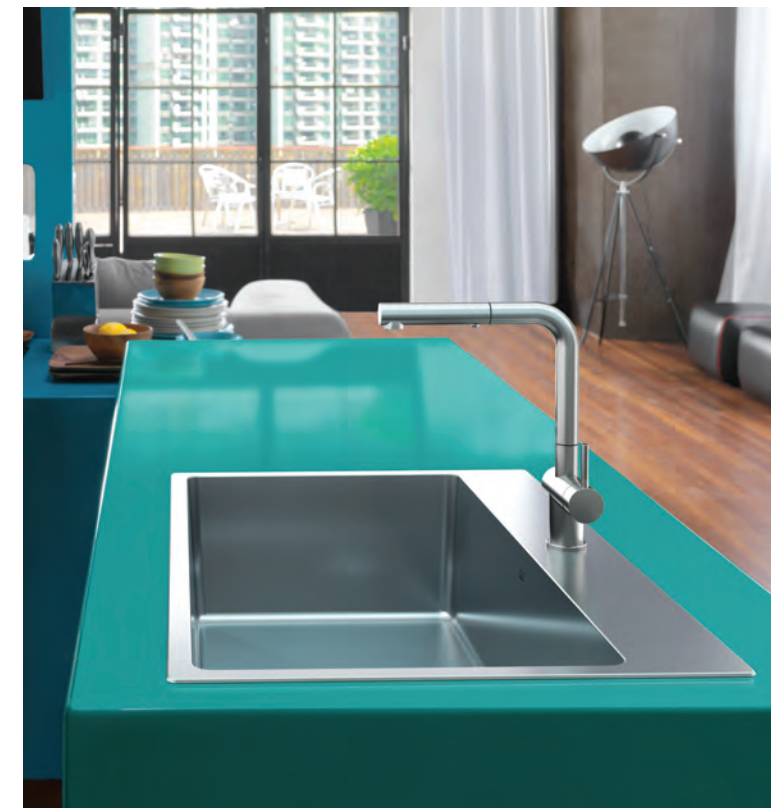



Made for Ease

Eliminate complicated, frustrating, and time-consuming traditional sink installation with Kindred's EZ Torque™ installation system, available on select Kindred sink models.

Our revolutionary installation system allows you to drop and drill your sink into place, securely locking the sink to the countertop. Easier installation means enjoying your kitchen sooner.

EZ TORQUE MEANS HASSLE-FREE INSTALLATION



DROP SINK INTO
THE COUNTERTOP.



TIGHTEN FASTENERS
TO SECURE IN PLACE.





Brookmore

ELEVATE YOUR HOME WITH CONTEMPORARY STYLE

The Brookmore sink collection redefines sophistication through its bold and stylish design, seamlessly balancing form with function. The satin finish adds a touch of refinement, making it the ideal choice to complement any kitchen interior. Find the perfect solution for any kitchen from our extensive range of models.





BROOKMORE

Undermount Sinks

CONTEMPORARY DURABLE SINKS

Brookmore undermount stainless steel sinks effortlessly elevate the aesthetics of modern, contemporary, or transitional homes.

Crafted from premium 18-gauge stainless steel enriched with a high chromium content, Brookmore sinks are designed to resist corrosion and inhibit bacterial growth. With a streamlined look and sleek satin finish, these sinks add a touch of elegance to your space and withstand everyday use, ensuring their enduring beauty for years to come.



SPACIOUS 9" DEEP BOWL

High capacity sink perfect for soaking and washing stacks of dishes.



REAR & OFFSET DRAINS

The placement of the drain has been designed to maximize bowl space.



HIGH QUALITY STAINLESS

18 gauge high quality stainless steel with exceptional resistance to staining and corrosion.



Pictured: BSU1832-9OW



Pictured: BDU1831-9

BSU1832-9 \$805.00
122.0637.645



Outside Sink Rim Dimensions: 18 1/8" FB x 32 1/2" LR
Single Bowl Dimensions: 16 1/2" FB x 30 7/8" LR x 9" DP
Minimum Cabinet Size: 33"
Gauge: 18
Corner Radius: 20mm
Finish: Satin Finish
Drain Hole Location: Rear
Sound Dampening: Sound Pads
Installation: Undermount
Shipping Weight: 22.2 lbs

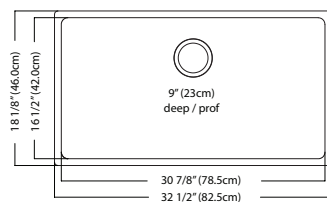

ACCESSORIES

- 1 Strainer Basket 1135 **Included**
- 2 Bottom Grid BG531S
- 7 Bamboo Cutting Board MB517
- 8 Roller Mat RM55S
- 9 Colander C417P

BSU1832-9OW \$805.00
122.0637.646



Outside Sink Rim Dimensions: 18 1/8" FB x 32 1/2" LR
Single Bowl Dimensions: 16 1/2" FB x 30 7/8" LR x 9" DP
Minimum Cabinet Size: 33"
Gauge: 18
Corner Radius: 20mm
Finish: Satin Finish
Drain Hole Location: Rear Offset
Sound Dampening: Sound Pads
Installation: Undermount
Shipping Weight: 24.8 lbs

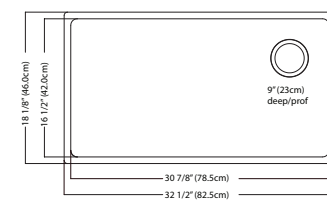

ACCESSORIES

- 1 Strainer Basket 1135 **Included**
- 3 Bottom Grid BG531OS
- 7 Bamboo Cutting Board MB517
- 8 Roller Mat RM55S
- 9 Colander C417P

BSU1831-9 \$780.00
122.0637.643



Outside Sink Rim Dimensions: 18 1/8" FB x 30 1/2" LR
Single Bowl Dimensions: 16 1/2" FB x 28 15/16" LR x 9" DP
Minimum Cabinet Size: 33"
Gauge: 18
Corner Radius: 20mm
Finish: Satin Finish
Drain Hole Location: Rear
Sound Dampening: Sound Pads
Installation: Undermount
Shipping Weight: 23 lbs

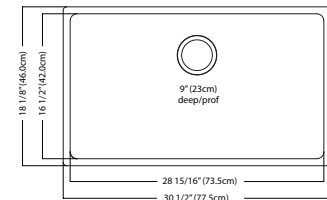

ACCESSORIES

- 1 Strainer Basket 1135 **Included**
- 4 Bottom Grid BG529S
- 7 Bamboo Cutting Board MB517
- 8 Roller Mat RM55S
- 9 Colander C417P

BSU1825-9 \$710.00
122.0637.641



Outside Sink Rim Dimensions: 18 1/8" FB x 24 5/8" LR
Single Bowl Dimensions: 16 1/2" FB x 23" LR x 9" DP
Minimum Cabinet Size: 27"
Gauge: 18
Corner Radius: 20mm
Finish: Satin Finish
Drain Hole Location: Rear
Sound Dampening: Sound Pads
Installation: Undermount
Shipping Weight: 18.3 lbs

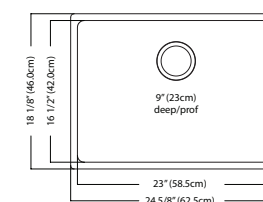

ACCESSORIES

- 1 Strainer Basket 1135 **Included**
- 5 Bottom Grid BG523S
- 7 Bamboo Cutting Board MB517
- 8 Roller Mat RM55S
- 9 Colander C417P

BSU1820-9 \$670.00
122.0637.639



Outside Sink Rim Dimensions: 18 1/8" FB x 19 1/2" LR
Single Bowl Dimensions: 16 1/2" FB x 17 15/16" LR x 9" DP
Minimum Cabinet Size: 21"
Gauge: 18
Corner Radius: 20mm
Finish: Satin Finish
Drain Hole Location: Rear
Sound Dampening: Sound Pads
Installation: Undermount
Shipping Weight: 15.8 lbs

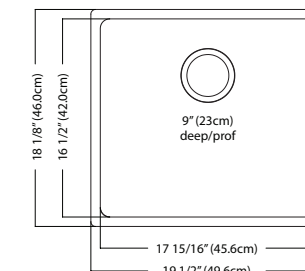

ACCESSORIES

- 1 Strainer Basket 1135 **Included**
- 6 Bottom Grid BG518S
- 7 Bamboo Cutting Board MB517
- 8 Roller Mat RM55S
- 9 Colander C417P

INCLUDED ACCESSORIES



1 Strainer Basket 1135
112.0040.566

OPTIONAL ACCESSORIES



2 Bottom Grid BG531S 112.0624.284 \$260.00
3 Bottom Grid BG531OS 112.0624.285 \$260.00
4 Bottom Grid BG529S 112.0624.283 \$250.00
5 Bottom Grid BG523S 112.0624.286 \$225.00



6 Bottom Grid BG518S 112.0624.287 \$210.00
7 Bamboo Cutting Board MB517 112.0624.298 \$210.00
8 Roller Mat RM55S 112.0058.824 \$245.00
9 Colander C417P 112.0538.950 \$100.00

BSU1816-9 \$655.00
122.0637.637



Outside Sink Rim Dimensions: 18 1/8" FB x 15 9/16" LR
Single Bowl Dimensions: 16 1/2" FB x 13 15/16" LR x 9" DP
Minimum Cabinet Size: 18"
Gauge: 18
Corner Radius: 20mm
Finish: Satin Finish
Drain Hole Location: Rear
Sound Dampening: Sound Pads
Installation: Undermount
Shipping Weight: 14 lbs

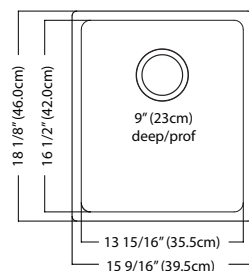

ACCESSORIES

- 1 Strainer Basket 1135 **Included**
- 2 Bottom Grid BG514S
- 6 Bamboo Cutting Board MB517
- 7 Roller Mat RM55S
- 8 Colander C417P

BSU1812-8 \$620.00
122.0637.635



Outside Sink Rim Dimensions: 18 1/8" FB x 11 9/16" LR
Single Bowl Dimensions: 16 1/2" FB x 10" LR x 7 7/8" DP
Minimum Cabinet Size: 15"
Gauge: 18
Corner Radius: 20mm
Finish: Satin Finish
Drain Hole Location: Rear
Sound Dampening: Sound Pads
Installation: Undermount
Shipping Weight: 11.5 lbs

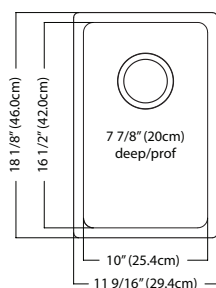

ACCESSORIES

- 1 Strainer Basket 1135 **Included**
- 3 Bottom Grid BG510S
- 6 Bamboo Cutting Board MB517
- 7 Roller Mat RM55S
- 8 Colander C417P

BCU1836R-9 \$990.00
122.0637.632



Outside Sink Rim Dimensions: 18 1/8" FB x 35 9/16" LR
Large Bowl Dimensions: 16 1/2" FB x 23" LR x 9" DP
Small Bowl Dimensions: 16 1/2" FB x 10" LR x 7 7/8" DP
Minimum Cabinet Size: 36"
Gauge: 18
Corner Radius: 20mm
Finish: Satin Finish
Drain Hole Location: Rear
Sound Dampening: Sound Pads
Installation: Undermount
Shipping Weight: 27.2 lbs

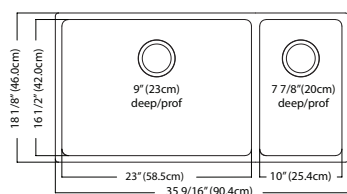

ACCESSORIES

- 1 Strainer Basket 1135 **2 Included**
- 3 Bottom Grid BG510S
- 4 Bottom Grid BG523S
- 6 Bamboo Cutting Board MB517
- 7 Roller Mat RM55S
- 8 Colander C417P

BCU1835R-9 \$965.00
122.0637.630



Outside Sink Rim Dimensions: 18 1/8" FB x 34 1/2" LR
Large Bowl Dimensions: 16 1/2" FB x 17 15/16" LR x 9" DP
Small Bowl Dimensions: 16 1/2" FB x 13 15/16" LR x 9" DP
Minimum Cabinet Size: 36"
Gauge: 18
Corner Radius: 20mm
Finish: Satin Finish
Drain Hole Location: Rear
Sound Dampening: Sound Pads
Installation: Undermount
Shipping Weight: 26.7 lbs

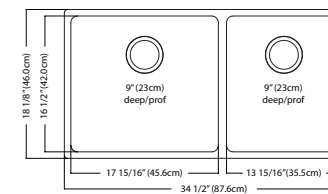

ACCESSORIES

- 1 Strainer Basket 1135 **2 Included**
- 2 Bottom Grid BG514S
- 5 Bottom Grid BG518S
- 6 Bamboo Cutting Board MB517
- 7 Roller Mat RM55S
- 8 Colander C417P

BCU1831R-9 \$940.00
122.0637.628



Outside Sink Rim Dimensions: 18 1/8" FB x 30 1/2" LR
Large Bowl Dimensions: 16 1/2" FB x 17 15/16" LR x 9" DP
Small Bowl Dimensions: 16 1/2" FB x 10" LR x 7 7/8" DP
Minimum Cabinet Size: 33"
Gauge: 18
Corner Radius: 20mm
Finish: Satin Finish
Drain Hole Location: Rear
Sound Dampening: Sound Pads
Installation: Undermount
Shipping Weight: 23.4 lbs

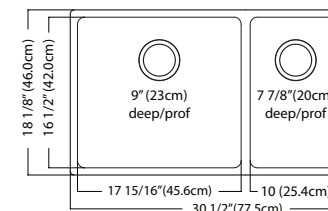

ACCESSORIES

- 1 Strainer Basket 1135 **2 Included**
- 3 Bottom Grid BG510S
- 5 Bottom Grid BG518S
- 6 Bamboo Cutting Board MB517
- 7 Roller Mat RM55S
- 8 Colander C417P

INCLUDED ACCESSORIES



1 Strainer Basket 1135
112.0040.566

OPTIONAL ACCESSORIES



2 Bottom Grid BG514S
112.0624.290
\$195.00



3 Bottom Grid BG510S
112.0624.292
\$190.00

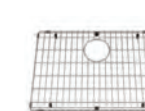

4 Bottom Grid BG523S
112.0624.286
\$225.00

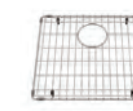

5 Bottom Grid BG518S
112.0624.287
\$210.00



6 Bamboo Cutting Board MB517
112.0624.298
\$210.00



7 Roller Mat RM55S
112.0058.824
\$245.00



8 Colander C417P
112.0538.950
\$100.00

BCU1827R-9 \$910.00
122.0637.626



Outside Sink Rim Dimensions: 18 1/8" FB x 26 9/16" LR
Large Bowl Dimensions: 16 1/2" FB x 13 15/16" LR x 9" DP
Small Bowl Dimensions: 16 1/2" FB x 10" LR x 7 7/8" DP
Minimum Cabinet Size: 27"
Gauge: 18
Corner Radius: 20mm
Finish: Satin Finish
Drain Hole Location: Rear
Sound Dampening: Sound Pads
Installation: Undermount
Shipping Weight: 22.2 lbs

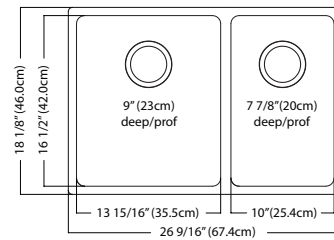

ACCESSORIES

- 1 Strainer Basket 1135 **2 Included**
- 2 Bottom Grid BG514S
- 3 Bottom Grid BG510S
- 4 Bamboo Cutting Board MB517
- 5 Roller Mat RM55S
- 6 Colander C417P

BDU1831-9 \$840.00
122.0637.633



Outside Sink Rim Dimensions: 18 1/8" FB x 30 1/2" LR
Equal Size Bowl Dimensions: 16 1/2" FB x 13 15/16" LR x 9" DP
Minimum Cabinet Size: 33"
Gauge: 18
Corner Radius: 20mm
Finish: Satin Finish
Drain Hole Location: Rear
Sound Dampening: Sound Pads
Installation: Undermount
Shipping Weight: 24.8 lbs

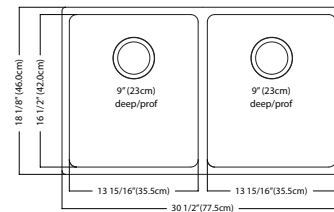

ACCESSORIES

- 1 Strainer Basket 1135 **2 Included**
- 2 Bottom Grid BG514S
- 4 Bamboo Cutting Board MB517
- 5 Roller Mat RM55S
- 6 Colander C417P

BTU1841-9 \$1,115.00
122.0637.647



Outside Sink Rim Dimensions: 18 1/8" FB x 41 1/2" LR
Equal Bowl Dimensions: 16 1/2" FB x 13 15/16" LR x 9" DP
Small Bowl Dimensions: 16 1/2" FB x 10" LR x 7 7/8" DP
Minimum Cabinet Size: 42"
Gauge: 18
Corner Radius: 20mm
Finish: Satin Finish
Drain Hole Location: Rear
Sound Dampening: Sound Pads
Installation: Undermount
Shipping Weight: 33 lbs

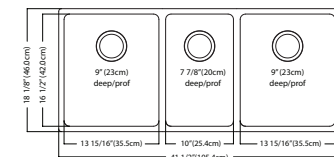

ACCESSORIES

- 1 Strainer Basket 1135 **3 Included**
- 2 Bottom Grid BG514S
- 3 Bottom Grid BG510S
- 4 Bamboo Cutting Board MB517
- 5 Roller Mat RM55S
- 6 Colander C417P



INCLUDED ACCESSORIES



- 1 Strainer Basket 1135
112.0040.566

OPTIONAL ACCESSORIES



- 2 Bottom Grid BG514S
112.0624.290
\$195.00



- 3 Bottom Grid BG510S
112.0624.292
\$190.00



- 4 Bamboo Cutting Board MB517
112.0624.298
\$210.00



- 5 Roller Mat RM55S
112.0058.824
\$245.00



- 6 Colander C417P
112.0538.950
\$100.00



BROOKMORE

Topmount / Drop In Sinks

REFINE, ENHANCE, UPGRADE

It's easy to change the look of any kitchen and create something that feels completely new without remodeling the entire space.

Our revolutionary EZ Torque™ installation system is a simplified fastener process that allows you to install the sink in just a few simple steps. Easier installation means enjoying your kitchen sooner.



SPACIOUS 9" DEEP BOWL

High capacity sink perfect for soaking and washing stacks of dishes.



EZ TORQUE INSTALLATION

Simplified fastener system and drop-and-drill process make this one of the industry's quickest sinks to install.



REAR & OFFSET DRAINS

The placement of the drain has been designed to maximize bowl space.



Pictured: BSL2131-9-1



Pictured: BSL2225-9-1

BSL2233-9-4 (4 faucet holes) \$780.00
101.0637.005

BSL2233-9-3 (3 faucet holes)
101.0637.003

BSL2233-9-1 (1 faucet hole)
101.0637.001



Outside Sink Rim Dimensions: 22" FB x 32 7/8" LR
Single Bowl Dimensions: 16 1/2" FB x 30 7/8" LR x 9" DP
Minimum Cabinet Size: 36"
Gauge: 18
Corner Radius: 20mm
Finish: Satin Finish
Drain Hole Location: Rear
Sound Dampening: Sound Pads
Installation: Topmount / Drop In
Shipping Weight: 23 lbs

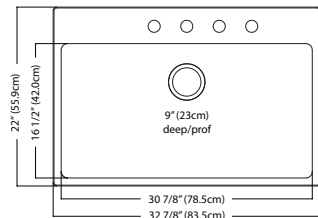

ACCESSORIES

- 1 Strainer Basket 1135 **Included**
- 2 Bottom Grid BG531S
- 6 Bamboo Cutting Board MB517
- 7 Roller Mat RM55S
- 8 Colander C417P



BSL2225-9-4 (4 faucet holes) \$730.00
101.0636.998

BSL2225-9-3 (3 faucet holes)
101.0636.996

BSL2225-9-1 (1 faucet hole)
101.0636.994



Outside Sink Rim Dimensions: 22" FB x 25" LR
Single Bowl Dimensions: 16 1/2" FB x 23" LR x 9" DP
Minimum Cabinet Size: 27"
Gauge: 18
Corner Radius: 20mm
Finish: Satin Finish
Drain Hole Location: Rear
Sound Dampening: Sound Pads
Installation: Topmount / Drop In
Shipping Weight: 19.2 lbs

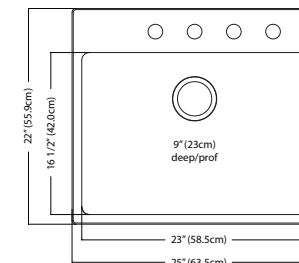

ACCESSORIES

- 1 Strainer Basket 1135 **Included**
- 5 Bottom Grid BG523S
- 6 Bamboo Cutting Board MB517
- 7 Roller Mat RM55S
- 8 Colander C417P



BSL2233-9-40W (4 faucet holes) \$780.00
101.0637.006

BSL2233-9-30W (3 faucet holes)
101.0637.004

BSL2233-9-10W (1 faucet hole)
101.0637.002



Outside Sink Rim Dimensions: 22" FB x 32 7/8" LR
Single Bowl Dimensions: 16 1/2" FB x 30 7/8" LR x 9" DP
Minimum Cabinet Size: 36"
Gauge: 18
Corner Radius: 20mm
Finish: Satin Finish
Drain Hole Location: Rear offset
Sound Dampening: Sound Pads
Installation: Topmount / Drop In
Shipping Weight: 23 lbs

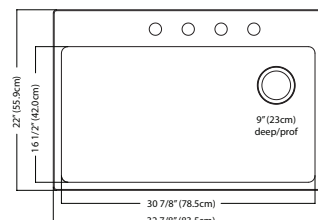

ACCESSORIES

- 1 Strainer Basket 1135 **Included**
- 3 Bottom Grid BG531OS
- 6 Bamboo Cutting Board MB517
- 7 Roller Mat RM55S
- 8 Colander C417P



BSL2125-9-4 (4 faucet holes) \$700.00
101.0636.986

BSL2125-9-3 (3 faucet holes)
101.0636.984

BSL2125-9-1 (1 faucet hole)
101.0636.982



Outside Sink Rim Dimensions: 20 7/8" FB x 25" LR
Single Bowl Dimensions: 16 1/2" FB x 23" LR x 9" DP
Minimum Cabinet Size: 27"
Gauge: 18
Corner Radius: 20mm
Finish: Satin Finish
Drain Hole Location: Rear
Sound Dampening: Sound Pads
Installation: Topmount / Drop In
Shipping Weight: 18.8 lbs

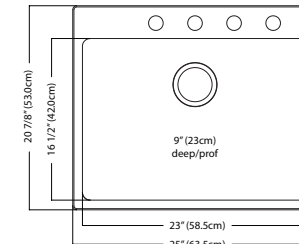

ACCESSORIES

- 1 Strainer Basket 1135 **Included**
- 5 Bottom Grid BG523S
- 6 Bamboo Cutting Board MB517
- 7 Roller Mat RM55S
- 8 Colander C417P



BSL2131-9-4 (4 faucet holes) \$750.00
101.0636.992

BSL2131-9-3 (3 faucet holes)
101.0636.990

BSL2131-9-1 (1 faucet hole)
101.0636.988



Outside Sink Rim Dimensions: 20 7/8" FB x 30 7/8" LR
Single Bowl Dimensions: 16 1/2" FB x 28 15/16" LR x 9" DP
Minimum Cabinet Size: 33"
Gauge: 18
Corner Radius: 20mm
Finish: Satin Finish
Drain Hole Location: Rear
Sound Dampening: Sound Pads
Installation: Topmount / Drop In
Shipping Weight: 23.2 lbs

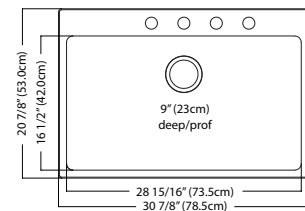

ACCESSORIES

- 1 Strainer Basket 1135 **Included**
- 4 Bottom Grid BG529S
- 6 Bamboo Cutting Board MB517
- 7 Roller Mat RM55S
- 8 Colander C417P



INCLUDED ACCESSORIES



1 Strainer Basket 1135
112.0040.566

OPTIONAL ACCESSORIES



2 Bottom Grid BG531S 112.0624.284 \$260.00
3 Bottom Grid BG531OS 112.0624.285 \$260.00
4 Bottom Grid BG529S 112.0624.283 \$250.00
5 Bottom Grid BG523S 112.0624.286 \$225.00



6 Bamboo Cutting Board MB517 112.0624.298 \$210.00
7 Roller Mat RM55S 112.0058.824 \$245.00
8 Colander C417P 112.0538.950 \$100.00

BSL2120-9-4 (4 faucet holes) \$590.00

101.0636.980

BSL2120-9-3 (3 faucet holes)

101.0636.978

BSL2120-9-1 (1 faucet hole)

101.0636.976



Outside Sink Rim Dimensions: 20 7/8" FB x 19 15/16" LR
Single Bowl Dimensions: 16 1/2" FB x 17 15/16" LR x 9" DP
Minimum Cabinet Size: 24"
Gauge: 18
Corner Radius: 20mm
Finish: Satin Finish
Drain Hole Location: Rear
Sound Dampening: Sound Pads
Installation: Topmount / Drop In
Shipping Weight: 15.6 lbs

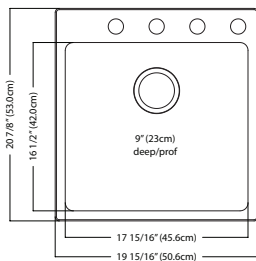

ACCESSORIES

- 1 Strainer Basket 1135 **Included**
- 2 Bottom Grid BG518S
- 6 Bamboo Cutting Board MB517
- 7 Roller Mat RM55S
- 8 Colander C417P



BSL2116-9-3 (3 faucet holes) \$560.00

101.0636.974

BSL2116-9-1 (1 faucet hole)

101.0636.972



Outside Sink Rim Dimensions: 20 7/8" FB x 15 15/16" LR
Single Bowl Dimensions: 16 1/2" FB x 13 15/16" LR x 9" DP
Minimum Cabinet Size: 18"
Gauge: 18
Corner Radius: 20mm
Finish: Satin Finish
Drain Hole Location: Rear
Sound Dampening: Sound Pads
Installation: Topmount / Drop In
Shipping Weight: 14.7 lbs

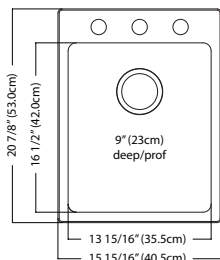

ACCESSORIES

- 1 Strainer Basket 1135 **Included**
- 3 Bottom Grid BG514S
- 6 Bamboo Cutting Board MB517
- 7 Roller Mat RM55S
- 8 Colander C417P



BCL2131R-9-4 (4 faucet holes) \$1,035.00

101.0636.952

BCL2131R-9-3 (3 faucet holes)

101.0636.950

BCL2131R-9-1 (1 faucet hole)

101.0636.948



Outside Sink Rim Dimensions: 20 7/8" FB x 30 7/8" LR
Large Bowl Dimensions: 16 1/2" FB x 17 15/16" LR x 9" DP
Small Bowl Dimensions: 16 1/2" FB x 10" LR x 7 7/8" DP
Minimum Cabinet Size: 33"
Gauge: 18
Corner Radius: 20mm
Finish: Satin Finish
Drain Hole Location: Rear
Sound Dampening: Sound Pads
Installation: Topmount / Drop In
Shipping Weight: 24.2 lbs

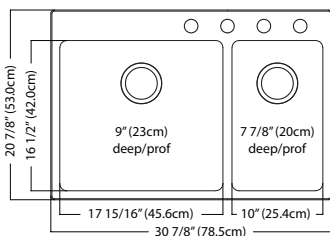

ACCESSORIES

- 1 Strainer Basket 1135 **2 Included**
- 2 Bottom Grid BG518S
- 4 Bottom Grid BG510S
- 6 Bamboo Cutting Board MB517
- 7 Roller Mat RM55S
- 8 Colander C417P



BCL2127R-9-4 (4 faucet holes) \$990.00

101.0636.946

BCL2127R-9-3 (3 faucet holes)

101.0636.944

BCL2127R-9-1 (1 faucet hole)

101.0636.942



Outside Sink Rim Dimensions: 20 7/8" FB x 26 15/16" LR
Large Bowl Dimensions: 16 1/2" FB x 13 15/16" LR x 9" DP
Small Bowl Dimensions: 16 1/2" FB x 10" LR x 7 7/8" DP
Minimum Cabinet Size: 30"
Gauge: 18
Corner Radius: 20mm
Finish: Satin Finish
Drain Hole Location: Rear
Sound Dampening: Sound Pads
Installation: Topmount / Drop In
Shipping Weight: 22.2 lbs

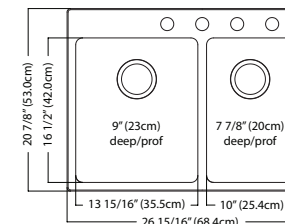

ACCESSORIES

- 1 Strainer Basket 1135 **2 Included**
- 3 Bottom Grid BG514S
- 4 Bottom Grid BG510S
- 6 Bamboo Cutting Board MB517
- 7 Roller Mat RM55S
- 8 Colander C417P



BDL2233-9-4 (4 faucet holes) \$940.00

101.0636.969

BDL2233-9-3 (3 faucet holes)

101.0636.968

BDL2233-9-1 (1 faucet hole)

101.0636.967



Outside Sink Rim Dimensions: 22" FB x 32 7/8" LR
Equal Size Bowl Dimensions: 16 1/2" FB x 14 15/16" LR x 9" DP
Minimum Cabinet Size: 36"
Gauge: 18
Corner Radius: 20mm
Finish: Satin Finish
Drain Hole Location: Rear
Sound Dampening: Sound Pads
Installation: Topmount / Drop In
Shipping Weight: 27 lbs

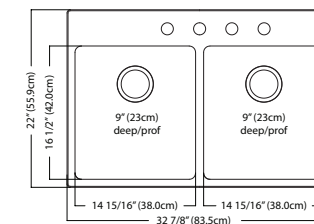

ACCESSORIES

- 1 Strainer Basket 1135 **2 Included**
- 5 Bottom Grid BG515S
- 6 Bamboo Cutting Board MB517
- 7 Roller Mat RM55S
- 8 Colander C417P



INCLUDED ACCESSORIES



- 1 Strainer Basket 1135
- 112.0040.566

OPTIONAL ACCESSORIES



- 2 Bottom Grid BG518S
- 112.0624.287
- \$210.00



- 3 Bottom Grid BG514S
- 112.0624.290
- \$195.00



- 4 Bottom Grid BG510S
- 112.0624.292
- \$190.00



- 5 Bottom Grid BG515S
- 112.0624.288
- \$200.00



- 6 Bamboo Cutting Board MB517
- 112.0624.298
- \$210.00



- 7 Roller Mat RM55S
- 112.0058.824
- \$245.00



- 8 Colander C417P
- 112.0538.950
- \$100.00

BDL2131-9-4 (4 faucet holes) \$805.00

101.0636.965

BDL2131-9-3 (3 faucet holes)

101.0636.963

BDL2131-9-1 (1 faucet hole)

101.0636.961



Outside Sink Rim Dimensions: 20 7/8" FB x 30 7/8" LR
 Equal Size Bowl Dimensions: 16 1/2" FB x 13 15/16" LR x 9" DP
 Minimum Cabinet Size: 33"
 Gauge: 18
 Corner Radius: 20mm
 Finish: Satin Finish
 Drain Hole Location: Rear
 Sound Dampening: Sound Pads
 Installation: Topmount / Drop In
 Shipping Weight: 24.2 lbs

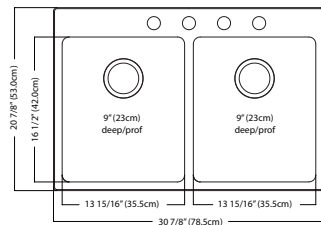

ACCESSORIES

- 1** Strainer Basket 1135 **2** Bottom Grid BG514S **3** Bamboo Cutting Board MB517 **4** Roller Mat RM55S **5** Colander C417P
- 2** Included



INCLUDED ACCESSORIES



1 Strainer Basket
1135
112.0040.566

OPTIONAL ACCESSORIES



2 Bottom Grid
BG514S
112.0624.290
\$195.00



3 Bamboo Cutting Board
MB517
112.0624.298
\$210.00



4 Roller Mat
RM55S
112.0058.824
\$245.00



5 Colander
C417P
112.0538.950
\$100.00





Pictured: BSL2233-ADA-1

BROOKMORE ADA Sinks

FUNCTIONAL DESIGN

Brookmore ADA sinks deliver a functional design that meets unique needs without sacrificing quality or style. Made to work with easy-to-clean corners, a resilient finish, and a sound dampening system, you can install these versatile dual mount sinks as an undermount or topmount.



ACCESSIBLE DESIGN

Shallow bowl depth and rear drain placement allows for sufficient knee space when sink is used in seated position.



EZ TORQUE SYSTEM

Simplified fastener system and drop-and-drill process make this one of the industry's quickest sinks to install.



DUAL MOUNT INSTALLATION

This sink can be mounted as a drop in or undermount, providing greater flexibility in choosing the countertop material.

BSL2225-ADA-1 (1 faucet hole) \$730.00
101.0689.852



Outside Sink Rim Dimensions: 22" FB x 25" LR
Single Bowl Dimensions: 16 1/2" FB x 23" LR x 5 3/8" DP
Minimum Cabinet Size: 27"
Gauge: 18
Corner Radius: 20mm
Finish: Satin Finish
Drain Hole Location: Rear
Sound Dampening: Sound Pads
Installation: Dual Mount
Shipping Weight: 19.2 lbs

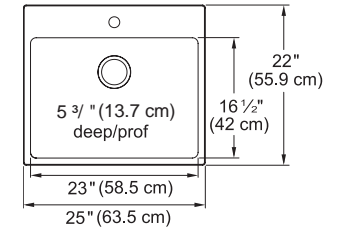

ACCESSORIES

- | | | | | |
|---|--------------------------------|--|------------------------------|----------------------------|
| 1 Strainer Basket
1135
<i>Included</i> | 3 Bottom Grid
BG523S | 4 Bamboo Cutting Board
MB517 | 5 Roller Mat
RM55S | 6 Colander
C417P |
|---|--------------------------------|--|------------------------------|----------------------------|



BSL2233-ADA-1 (1 faucet hole) \$780.00
101.0689.855



Outside Sink Rim Dimensions: 22" FB x 32 7/8" LR
Single Bowl Dimensions: 16 1/2" FB x 30 7/8" LR x 5 3/8" DP
Minimum Cabinet Size: 36"
Gauge: 18
Corner Radius: 20mm
Finish: Satin Finish
Drain Hole Location: Rear
Sound Dampening: Sound Pads
Installation: Dual Mount
Shipping Weight: 23 lbs

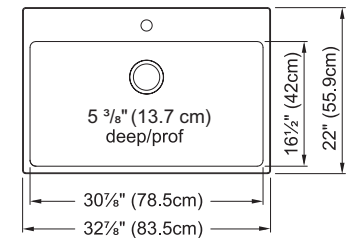

ACCESSORIES

- | | | | | |
|---|--------------------------------|--|------------------------------|----------------------------|
| 1 Strainer Basket
1135
<i>Included</i> | 2 Bottom Grid
BG531S | 4 Bamboo Cutting Board
MB517 | 5 Roller Mat
RM55S | 6 Colander
C417P |
|---|--------------------------------|--|------------------------------|----------------------------|



INCLUDED ACCESSORIES



- 1** Strainer Basket
1135
112.0040.566

OPTIONAL ACCESSORIES



- 2** Bottom Grid
BG531S
112.0624.284
\$260.00



- 3** Bottom Grid
BG523S
112.0624.286
\$225.00



- 4** Bamboo Cutting Board
MB517
112.0624.298
\$210.00



- 5** Roller Mat
RM55S
112.0058.824
\$245.00



- 6** Colander
C417P
112.0538.950
\$100.00

* ADA Compliant: Product is compliant with the American Disabilities Act when properly installed



Steel Queen®

THE CROWNING TOUCH

Our Steel Queen sinks have a long and proud history in the plumbing industry. Their trusted reputation owes itself to decades of refining innovative design, ease of installation, and our dedication to unmatched quality and craftsmanship.

Get to know our Queen – proudly bearing the Kindred Crown since 1954.

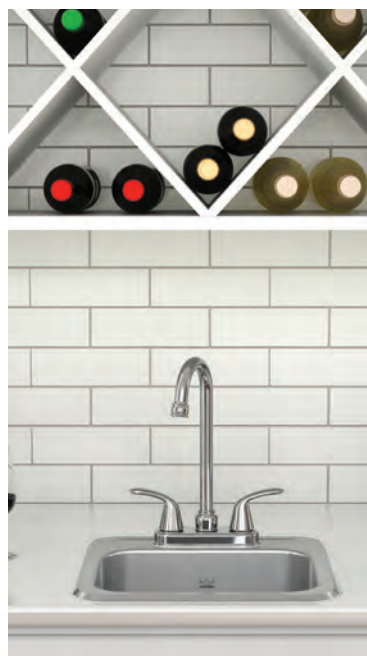



STEEL QUEEN

Undermount Sinks

CLASSICALLY RELIABLE

Kindred Steel Queen sinks offer versatile durability in a wide variety of styles.

These classic sinks seamlessly complement and accentuate solid-surface countertops anywhere in the house. Equipped with a durable finish to ensure your sink will shine for years to come, even through the growing demands of everyday life.



UNDERMOUNT INSTALLATION

Seamless profile brings sleek style to any kitchen.



ULTRA QUIET

Sound dampening system that keeps your kitchen clear of excess noise from running water and disposal vibration.



STYLE & VERSATILITY

Choose from a wide range of shapes, sizes and styles to suit any kitchen.



Pictured: QSU1113-6



Pictured: QDUA1831-8

QSU1933-8 \$760.00
122.0170.398



Outside Sink Rim Dimensions: 18 3/4" FB x 32 3/4" LR
Single Bowl Dimensions: 17" FB x 31" LR x 8" DP
Minimum Cabinet Size: 33"
Gauge: 20
Corner Radius: 50mm
Finish: Satin Finished Bowl with Silk Finished Rim
Drain Hole Location: Rear
Sound Dampening: Undercoating
Installation: Undermount
Shipping Weight: 17.6 lbs

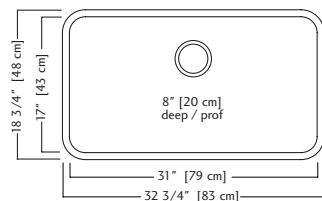

ACCESSORIES

- 1 Strainer Basket 1135 **Included**
- 2 Bottom Grid BGA3117S
- 7 Drainer Basket DBR10S
- 8 Bamboo Bridge Cutting Board 112.0654.749

QSU1831-8 \$700.00
122.0370.142



Outside Sink Rim Dimensions: 17 3/4" FB x 30 3/4" LR
Single Bowl Dimensions: 16" FB x 29" LR x 8" DP
Minimum Cabinet Size: 33"
Gauge: 20
Corner Radius: 50mm
Finish: Satin Finished Bowl with Silk Finished Rim
Drain Hole Location: Rear
Sound Dampening: Undercoating
Installation: Undermount
Shipping Weight: 13.5 lbs

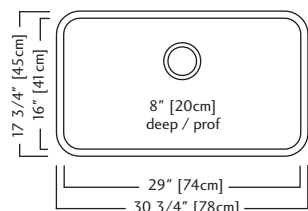

ACCESSORIES

- 1 Strainer Basket 1135 **Included**
- 3 Bottom Grid BG240S
- 7 Drainer Basket DBR10S
- 8 Bamboo Bridge Cutting Board 112.0654.749
- 9 Roller Mat RM55S

QSU1925-8 \$680.00



Outside Sink Rim Dimensions: 18 3/4" FB x 24 3/4" LR
Single Bowl Dimensions: 17" FB x 23" LR x 8" DP
Minimum Cabinet Size: 27"
Gauge: 20
Corner Radius: 50mm
Finish: Satin Finished Bowl with Silk Finished Rim
Drain Hole Location: Rear
Sound Dampening: Undercoating
Installation: Undermount
Shipping Weight: 14.5 lbs

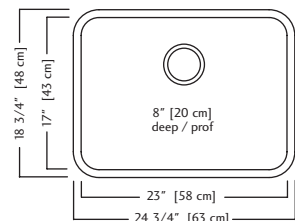

ACCESSORIES

- 1 Strainer Basket 1135 **Included**
- 4 Bottom Grid BGA2317S
- 7 Drainer Basket DBR10S
- 8 Bamboo Bridge Cutting Board 112.0654.749

QSU1922-8 \$655.00
122.0486.890



Outside Sink Rim Dimensions: 18 3/4" FB x 21 3/4" LR
Single Bowl Dimensions: 17" FB x 20" LR x 8" DP
Minimum Cabinet Size: 24"
Gauge: 20
Corner Radius: 50mm
Finish: Satin Finished Bowl with Silk Finished Rim
Drain Hole Location: Rear
Sound Dampening: Undercoating
Installation: Undermount
Shipping Weight: 12.1 lbs

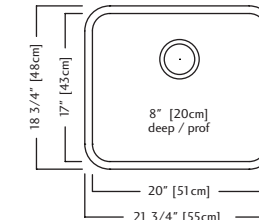

ACCESSORIES

- 1 Strainer Basket 1135 **Included**
- 5 Bottom Grid BG14S
- 7 Drainer Basket DBR10S
- 8 Bamboo Bridge Cutting Board 112.0654.749

QSU1917-8 \$585.00
122.0170.400



Outside Sink Rim Dimensions: 18 3/4" FB x 16 3/4" LR
Single Bowl Dimensions: 17" FB x 15" LR x 8" DP
Minimum Cabinet Size: 18"
Gauge: 20
Corner Radius: 50mm
Finish: Satin Finished Bowl with Silk Finished Rim
Drain Hole Location: Rear
Sound Dampening: Undercoating
Installation: Undermount
Shipping Weight: 9.2 lbs

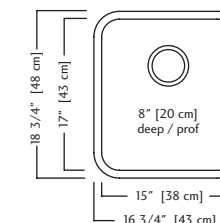

ACCESSORIES

- 1 Strainer Basket 1135 **Included**
- 6 Bottom Grid BGA1517S
- 7 Drainer Basket DBR10S
- 8 Bamboo Bridge Cutting Board 112.0654.749

INCLUDED ACCESSORIES



1 Strainer Basket 1135 112.0040.566

OPTIONAL ACCESSORIES



2 Bottom Grid BGA3117S 112.0174.878 \$265.00



3 Bottom Grid BG240S 112.0204.314 \$270.00



4 Bottom Grid BGA2317S 112.0174.875 \$235.00

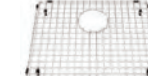

5 Bottom Grid BG14S 112.0486.240 \$185.00



6 Bottom Grid BGA1517S 112.0174.872 \$185.00



7 Drainer Basket DBR10S 112.0044.784 \$200.00



8 Bamboo Bridge Cutting Board 112.0654.749 \$210.00



9 Roller Mat RM55S 112.0058.824 \$245.00

QSU1820-8 \$455.00
122.0170.399



Outside Sink Rim Dimensions: 17 3/4" FB x 19 3/4" LR
Single Bowl Dimensions: 16" FB x 18" LR x 8" DP
Minimum Cabinet Size: 21"
Gauge: 20
Corner Radius: 50mm
Finish: Satin Finished Bowl with Silk Finished Rim
Drain Hole Location: Rear
Sound Dampening: Undercoating
Installation: Undermount
Shipping Weight: 9.3 lbs

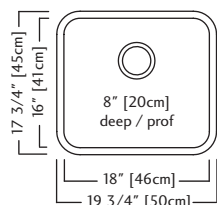

ACCESSORIES

- 1 Strainer Basket 1135 **Included**
- 2 Bottom Grid BG11S
- 6 Drainer Basket DBR10S
- 7 Bamboo Bridge Cutting Board 112.0654.749
- 8 Roller Mat RM55S

QSU1616-6 \$415.00
122.0484.875



Outside Sink Rim Dimensions: 15 3/4" FB x 15 3/4" LR
Single Bowl Dimensions: 14" FB x 14" LR x 6" DP
Minimum Cabinet Size: 18"
Gauge: 20
Corner Radius: 50mm
Finish: Satin Finished Bowl with Silk Finished Rim
Drain Hole Location: Rear
Sound Dampening: Undercoating
Installation: Undermount
Shipping Weight: 5.5 lbs

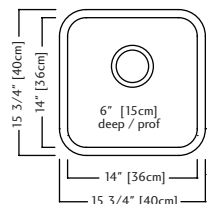

ACCESSORIES

- 1 Strainer Basket 1135 **Included**
- 7 Bamboo Bridge Cutting Board 112.0654.749
- 8 Roller Mat RM55S

QSU1816-8 \$435.00
122.0202.335



Outside Sink Rim Dimensions: 17 3/4" FB x 15 3/4" LR
Single Bowl Dimensions: 16" FB x 14" LR x 8" DP
Minimum Cabinet Size: 18"
Gauge: 20
Corner Radius: 50mm
Finish: Satin Finished Bowl with Silk Finished Rim
Drain Hole Location: Rear
Sound Dampening: Undercoating
Installation: Undermount
Shipping Weight: 7.1 lbs

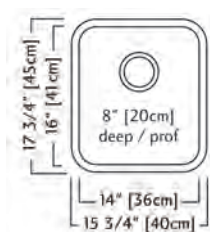

ACCESSORIES

- 1 Strainer Basket 1135 **Included**
- 3 Bottom Grid BG10S
- 6 Drainer Basket DBR10S
- 7 Bamboo Bridge Cutting Board 112.0654.749
- 8 Roller Mat RM55S

QSU1113-6 \$310.00
122.0311.979



Outside Sink Rim Dimensions: 11" FB x 13 3/8" LR
Single Bowl Dimensions: 9 1/4" FB x 11 5/8" LR x 6" DP
Minimum Cabinet Size: 15"
Gauge: 20
Corner Radius: 50mm
Finish: Satin Finished Bowl with Silk Finished Rim
Drain Hole Location: Center
Sound Dampening: Undercoating
Installation: Undermount
Shipping Weight: 3.8 lbs

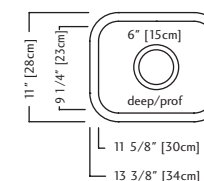

ACCESSORIES

- 1 Strainer Basket 1135 **Included**
- 7 Bamboo Bridge Cutting Board 112.0654.749

QCUA1933R-8 \$1,085.00
122.0170.396



Outside Sink Rim Dimensions: 18 3/4" FB x 32 7/8" LR
Large Bowl Dimensions: 17" FB x 18" LR x 8" DP
Small Bowl Dimensions: 17" FB x 12" LR x 7" DP
Minimum Cabinet Size: 33"
Gauge: 20
Corner Radius: 50mm
Finish: Satin Finished Bowls with Silk Finished Rim
Drain Hole Location: Rear
Sound Dampening: Undercoating
Installation: Undermount
Shipping Weight: 17.2 lbs

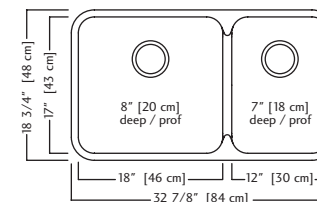

ACCESSORIES

- 1 Strainer Basket 1135 **2 Included**
- 4 Bottom Grid BGA1817S
- 5 Bottom Grid BGA1217S
- 6 Drainer Basket DBR10S
- 7 Bamboo Bridge Cutting Board 112.0654.749

INCLUDED ACCESSORIES



1 Strainer Basket 1135
112.0040.566

OPTIONAL ACCESSORIES

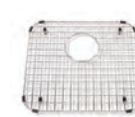

2 Bottom Grid BG11S
112.0044.786
\$175.00

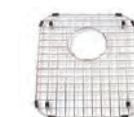

3 Bottom Grid BG10S
112.0044.785
\$185.00



4 Bottom Grid BGA1817S
112.0174.876
\$200.00



5 Bottom Grid BGA1217S
112.0174.874
\$140.00



6 Drainer Basket DBR10S
112.0044.784
\$200.00



7 Bamboo Bridge Cutting Board 112.0654.749
\$210.00



8 Roller Mat RM55S
112.0058.824
\$245.00

QCUA1831R-8 (as shown) \$1,015.00

122.0202.322

QCUA1831L-8 (small bowl left)

122.0202.324



Outside Sink Rim Dimensions: 17 3/4" FB x 30 7/8" LR
 Large Bowl Dimensions: 16" FB x 18" LR x 8" DP
 Small Bowl Dimensions: 16" FB x 10" LR x 7" DP
 Minimum Cabinet Size: 33"
 Gauge: 20
 Corner Radius: 50mm
 Finish: Satin Finished Bowls with Silk Finished Rim
 Drain Hole Location: Rear
 Sound Dampening: Undercoating
 Installation: Undermount
 Shipping Weight: 17 lbs

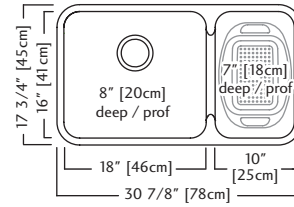

ACCESSORIES

- 1** Strainer Basket 1135 **2** Colander CA1W **3** Bottom Grid BG13S **4** Bottom Grid BG11S **7** Drainer Basket DBR10S **8** Bamboo Bridge Cutting Board 112.0654.749 **9** Roller Mat RM55S
- 2 Included** **Included**

QCUA1827R-8 (as shown) \$910.00

122.0202.327

QCUA1827L-8 (small bowl left)

122.0202.329



Outside Sink Rim Dimensions: 17 3/4" FB x 26 7/8" LR
 Large Bowl Dimensions: 16" FB x 14" LR x 8" DP
 Small Bowl Dimensions: 16" FB x 10" LR x 7" DP
 Minimum Cabinet Size: 30"
 Gauge: 20
 Corner Radius: 50mm
 Finish: Satin Finished Bowls with Silk Finished Rim
 Drain Hole Location: Rear
 Sound Dampening: Undercoating
 Installation: Undermount
 Shipping Weight: 13.8 lbs

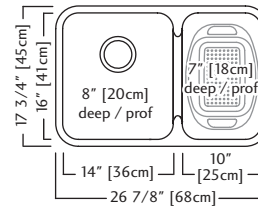

ACCESSORIES

- 1** Strainer Basket 1135 **2** Colander CA1W **3** Bottom Grid BG13S **5** Bottom Grid BG10S **7** Drainer Basket DBR10S **8** Bamboo Bridge Cutting Board 112.0654.749 **9** Roller Mat RM55S
- 2 Included** **Included**

QDUA1933-8 \$835.00

122.0170.394



Outside Sink Rim Dimensions: 18 3/4" FB x 32 7/8" LR
 Equal Size Bowl Dimensions: 17" FB x 15" LR x 8" DP
 Minimum Cabinet Size: 33"
 Gauge: 20
 Corner Radius: 50mm
 Finish: Satin Finished Bowls with Silk Finished Rim
 Drain Hole Location: Rear
 Sound Dampening: Undercoating
 Installation: Undermount
 Shipping Weight: 16.1 lbs

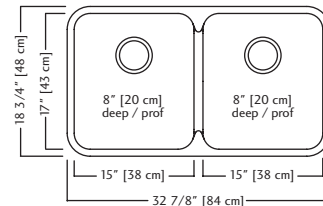

ACCESSORIES

- 1** Strainer Basket 1135 **2** Colander CA1W **6** Bottom Grid BGA1517S **7** Drainer Basket DBR10S **8** Bamboo Bridge Cutting Board 112.0654.749 **9** Roller Mat RM55S
- 2 Included**

QDUA1831-8 \$745.00

122.0187.705



Outside Sink Rim Dimensions: 17 3/4" FB x 30 7/8" LR
 Equal Size Bowl Dimensions: 16" FB x 14" LR x 8" DP
 Minimum Cabinet Size: 33"
 Gauge: 20
 Corner Radius: 50mm
 Finish: Satin Finished Bowls with Silk Finished Rim
 Drain Hole Location: Rear
 Sound Dampening: Undercoating
 Installation: Undermount
 Shipping Weight: 16.0 lbs

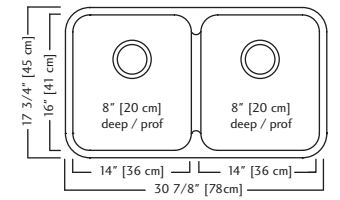

ACCESSORIES

- 1** Strainer Basket 1135 **5** Bottom Grid BG10S **7** Drainer Basket DBR10S **8** Bamboo Bridge Cutting Board 112.0654.749 **9** Roller Mat RM55S
- 2 Included**

INCLUDED
ACCESSORIES

- 1** Strainer Basket 1135 112.0040.566 **2** Colander CA1W 112.0202.209 **On select models as indicated**

OPTIONAL
ACCESSORIES

- 3** Bottom Grid BG13S 112.0367.605 \$160.00 **4** Bottom Grid BG11S 112.0044.786 \$175.00 **5** Bottom Grid BG10S 112.0044.785 \$185.00 **6** Bottom Grid BGA1517S 112.0174.872 \$185.00



- 7** Drainer Basket DBR10S 112.0044.784 \$200.00 **8** Bamboo Bridge Cutting Board 112.0654.749 \$210.00 **9** Roller Mat RM55S 112.0058.824 \$245.00



STEEL QUEEN

Topmount / Drop In Sinks

A BEAUTIFUL HISTORY

Combining design and durability worthy of the Kindred Crown, Steel Queen sinks have been a homeowner's favorite for years.

Kindred's drop in sinks are widely regarded as some of the easiest-to-install. Simple enough for a DIY project, these versatile models are the top choice of many home renovators.



STYLE & VERSATILITY

Choose from a wide range of shapes, sizes and styles to suit any kitchen.



EZ TORQUE INSTALLATION

Simplified fastener system and drop-and-drill process make this one of the industry's quickest sinks to install.



REAR DRAIN

The placement of the drain has been designed to maximize bowl space.



Pictured: QDLA2233-8-1



Pictured: QSLA2233-8-1

QSLA2233-8-4 (4 faucet holes) \$830.00

101.0169.277

QSLA2233-8-3 (3 faucet holes)

101.0169.276

QSLA2233-8-1 (1 faucet hole)

101.0169.275



Outside Sink Rim Dimensions: 22" FB x 33 3/8" LR
Single Bowl Dimensions: 17" FB x 31" LR x 8" DP
Minimum Cabinet Size: 36"
Gauge: 20
Corner Radius: 50mm
Finish: Satin Finished Bowl with Mirror Finished Rim
Drain Hole Location: Rear
Sound Dampening: Undercoating
Installation: Topmount / Drop In
Shipping Weight: 16.4 lbs

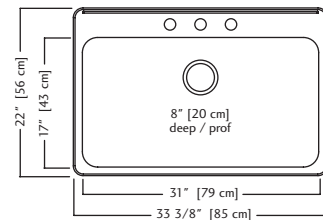

ACCESSORIES

- 1** Strainer Basket 1135 **2** Bottom Grid BGA3117S **7** Drainer Basket DBR10S **8** Roller Mat RM55S
Included



QSLA2217-8-3 (3 faucet holes) \$560.00

101.0169.282

QSLA2217-8-1 (1 faucet hole)

101.0169.281



Outside Sink Rim Dimensions: 22" FB x 17 1/4" LR
Single Bowl Dimensions: 17" FB x 15" LR x 8" DP
Minimum Cabinet Size: 21"
Gauge: 20
Corner Radius: 50mm
Finish: Satin Finished Bowl with Mirror Finished Rim
Drain Hole Location: Rear
Sound Dampening: Undercoating
Installation: Topmount / Drop In
Shipping Weight: 9.3 lbs

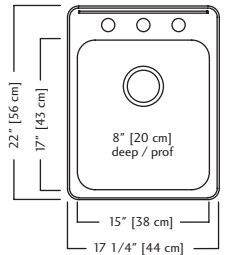

ACCESSORIES

- 1** Strainer Basket 1135 **5** Bottom Grid BGA1517S **7** Drainer Basket DBR10S **8** Roller Mat RM55S
Included



QSLA2031-8-4 (4 faucet holes) \$805.00

101.0202.189

QSLA2031-8-3 (3 faucet holes)

101.0202.187

QSLA2031-8-1 (1 faucet hole)

101.0202.185



Outside Sink Rim Dimensions: 20 1/2" FB x 31 1/4" LR
Single Bowl Dimensions: 16" FB x 29" LR x 8" DP
Minimum Cabinet Size: 33"
Gauge: 20
Corner Radius: 50mm
Finish: Satin Finished Bowl with Mirror Finished Rim
Drain Hole Location: Rear
Sound Dampening: Undercoating
Installation: Topmount / Drop In
Shipping Weight: 14.7 lbs

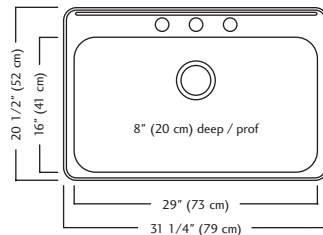

ACCESSORIES

- 1** Strainer Basket 1135 **3** Bottom Grid BG240S **7** Drainer Basket DBR10S **8** Roller Mat RM55S
Included



QSL2020-8-3 (3 faucet holes) \$455.00

101.0045.230

QSL2020-8-1 (1 faucet hole)

101.0045.229



Outside Sink Rim Dimensions: 20 1/2" FB x 20" LR
Single Bowl Dimensions: 16" FB x 18" LR x 8" DP
Minimum Cabinet Size: 24"
Gauge: 20
Corner Radius: 50mm
Finish: Satin Finished Bowl with Mirror Finished Rim
Drain Hole Location: Rear
Sound Dampening: Undercoating
Installation: Topmount / Drop In
Shipping Weight: 9.7 lbs

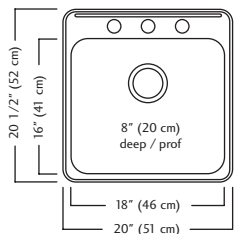

ACCESSORIES

- 1** Strainer Basket 1135 **6** Bottom Grid BG11S **7** Drainer Basket DBR10S **8** Roller Mat RM55S
Included



QSLA2225-8-4 (4 faucet holes) \$730.00

101.0169.280

QSLA2225-8-3 (3 faucet holes)

101.0169.279

QSLA2225-8-1 (1 faucet hole)

101.0169.278



Outside Sink Rim Dimensions: 22" FB x 25 1/4" LR
Single Bowl Dimensions: 17" FB x 23" LR x 8" DP
Minimum Cabinet Size: 27"
Gauge: 20
Corner Radius: 50mm
Finish: Satin Finished Bowl with Mirror Finished Rim
Drain Hole Location: Rear
Sound Dampening: Undercoating
Installation: Topmount / Drop In
Shipping Weight: 15.0 lbs

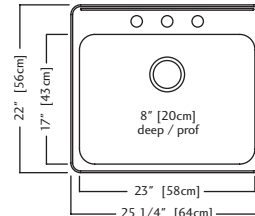

ACCESSORIES

- 1** Strainer Basket 1135 **4** Bottom Grid BGA2317S **7** Drainer Basket DBR10S **8** Roller Mat RM55S
Included



INCLUDED ACCESSORIES



- 1** Strainer Basket 1135
112.0040.566

OPTIONAL ACCESSORIES



- 2** Bottom Grid BGA3117S
112.0174.878
\$265.00



- 3** Bottom Grid BG240S
112.0204.314
\$270.00



- 4** Bottom Grid BGA2317S
112.0174.875
\$235.00



- 5** Bottom Grid BGA1517S
112.0174.872
\$185.00

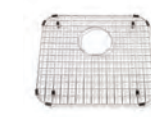

- 6** Bottom Grid BG11S
112.0044.786
\$175.00



- 7** Drainer Basket DBR10S
112.0044.784
\$200.00



- 8** Roller Mat RM55S
112.0058.824
\$245.00

QSA1820-8 \$445.00
101.0202.331



Outside Sink Rim Dimensions: 18 1/8" FB x 20 1/8" LR
Single Bowl Dimensions: 16" FB x 18" LR x 8" DP
Minimum Cabinet Size: 24"
Gauge: 20
Corner Radius: 50mm
Finish: Satin Finished Bowl with Mirror Finished Rim
Drain Hole Location: Rear
Sound Dampening: Undercoating
Installation: Topmount / Drop In
Shipping Weight: 9.9 lbs

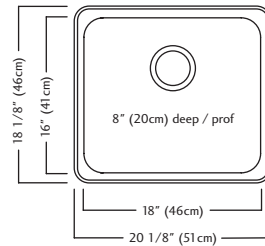

ACCESSORIES

- 1** Strainer Basket 1135 **Included**
- 3** Bottom Grid BG11S
- 7** Drainer Basket DBR10S
- 8** Bamboo Bridge Cutting Board 112.0654.749
- 9** Roller Mat RM55S



QSA1816-8 \$435.00
101.0202.339



Outside Sink Rim Dimensions: 18 1/8" FB x 16 1/8" LR
Single Bowl Dimensions: 16" FB x 14" LR x 8" DP
Minimum Cabinet Size: 18"
Gauge: 20
Corner Radius: 50mm
Finish: Satin Finished Bowl with Mirror Finished Rim
Drain Hole Location: Rear
Sound Dampening: Undercoating
Installation: Topmount / Drop In
Shipping Weight: 8.2 lbs

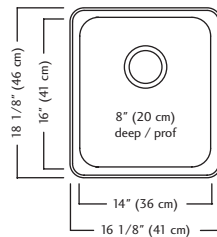

ACCESSORIES

- 1** Strainer Basket 1135 **Included**
- 4** Bottom Grid BG10S
- 7** Drainer Basket DBR10S
- 8** Bamboo Bridge Cutting Board 112.0654.749
- 9** Roller Mat RM55S



QSL2020-7-3 (3 faucet holes) \$350.00
101.0045.226

QSL2020-7-1 (1 faucet hole)
101.0045.225



Outside Sink Rim Dimensions: 20 1/2" FB x 20" LR
Single Bowl Dimensions: 16" FB x 18" LR x 7" DP
Minimum Cabinet Size: 24"
Gauge: 20
Corner Radius: 50mm
Finish: Satin Finished Bowl with Mirror Finished Rim
Drain Hole Location: Rear
Sound Dampening: Undercoating
Installation: Topmount / Drop In
Shipping Weight: 9.2 lbs

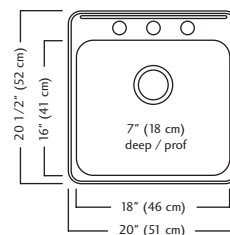

ACCESSORIES

- 1** Strainer Basket 1135 **Included**
- 3** Bottom Grid BG11S
- 7** Drainer Basket DBR10S
- 9** Roller Mat RM55S



QCLA2031R-8 (as shown)
QCLA2031R-8-3 (3 faucet holes)
101.0201.838

QCLA2031R-8-1 (1 faucet hole)
101.0201.835



QCLA2031L-8 (small bowl left) \$1,040.00
QCLA2031L-8-3 (3 faucet holes)
101.0201.844

QCLA2031L-8-1 (1 faucet hole)
101.0201.842

Outside Sink Rim Dimensions: 20 1/2" FB x 31 1/4" LR
Large Bowl Dimensions: 16" FB x 18" LR x 8" DP
Small Bowl Dimensions: 16" FB x 10" LR x 7" DP
Minimum Cabinet Size: 33"
Gauge: 20
Corner Radius: 50mm
Finish: Satin Finished Bowls with Mirror Finished Rim
Drain Hole Location: Rear
Sound Dampening: Undercoating
Installation: Topmount / Drop In
Shipping Weight: 15.9 lbs

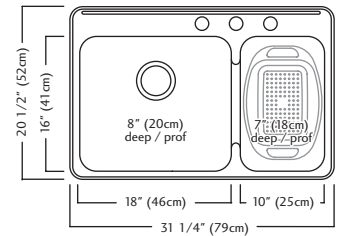

ACCESSORIES

- 1** Strainer Basket 1135 **2 Included**
- 2** Colander CA1W **Included**
- 3** Bottom Grid BG11S
- 5** Bottom Grid BG13S
- 7** Drainer Basket DBR10S
- 9** Roller Mat RM55S



QDLA2233-8-4 (4 faucet holes) \$1,015.00
101.0169.266

QDLA2233-8-3 (3 faucet holes)
101.0169.265

QDLA2233-8-1 (1 faucet hole)
101.0169.264



Outside Sink Rim Dimensions: 22" FB x 33 3/8" LR
Equal Size Bowl Dimensions: 17" FB x 15" LR x 8" DP
Minimum Cabinet Size: 36"
Gauge: 20
Corner Radius: 50mm
Finish: Satin Finished Bowls with Mirror Finished Rim
Drain Hole Location: Rear
Sound Dampening: Undercoating
Installation: Topmount / Drop In
Shipping Weight: 17.2 lbs

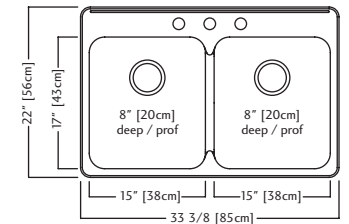

ACCESSORIES

- 1** Strainer Basket 1135 **2 Included**
- 6** Bottom Grid BGA1517S
- 7** Drainer Basket DBR10S
- 9** Roller Mat RM55S



INCLUDED ACCESSORIES

OPTIONAL ACCESSORIES



- 1** Strainer Basket 1135
112.0040.566

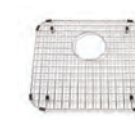

- 3** Bottom Grid BG11S
112.0044.786
\$175.00

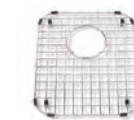

- 4** Bottom Grid BG10S
112.0044.785
\$185.00



- 5** Bottom Grid BG13S
112.0367.605
\$160.00



- 6** Bottom Grid BGA1517S
112.0174.872
\$185.00



- 2** Colander CA1W
112.0202.209
On select models as indicated



- 7** Drainer Basket DBR10S
112.0044.784
\$200.00



- 8** Bamboo Bridge Cutting Board
112.0654.749
\$210.00



- 9** Roller Mat RM55S
112.0058.824
\$245.00

QCLA2027R-8 (as shown)
QCLA2027R-8-3 (3 faucet holes)
101.0202.031

QCLA2027R-8-1 (1 faucet hole)
101.0202.029



QCLA2027L-8 (small bowl left) \$1,000.00
QCLA2027L-8-3 (3 faucet holes)
101.0202.172

QCLA2027L-8-1 (1 faucet hole)
101.0202.160

Outside Sink Rim Dimensions: 20 9/16" FB x 27 1/4" LR
Large Bowl Dimensions: 16" FB x 14" LR x 8" DP
Small Bowl Dimensions: 16" FB x 10" LR x 7" DP
Minimum Cabinet Size: 30"
Gauge: 20
Corner Radius: 50mm
Finish: Satin Finished Bowls with Mirror Finished Rim
Drain Hole Location: Rear
Sound Dampening: Undercoating
Installation: Topmount / Drop In
Shipping Weight: 15.1 lbs

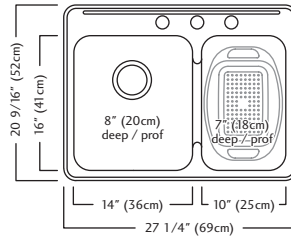

ACCESSORIES

- 1 Strainer Basket 1135 **2 Included**
2 Colander CA1W **Included**
3 Bottom Grid BG10S
4 Bottom Grid BG13S
5 Drainer Basket DBR10S
7 Roller Mat RM55S



QD1831-8 \$700.00
101.0045.147



Outside Sink Rim Dimensions: 18 7/16" FB x 31 1/4" LR
Equal Size Bowl Dimensions: 16" FB x 14" LR x 8" DP
Minimum Cabinet Size: 33"
Gauge: 20
Corner Radius: 50mm
Finish: Satin Finished Bowls with Mirror Finished Rim
Drain Hole Location: Rear
Sound Dampening: Undercoating
Installation: Topmount / Drop In
Shipping Weight: 17.2 lbs

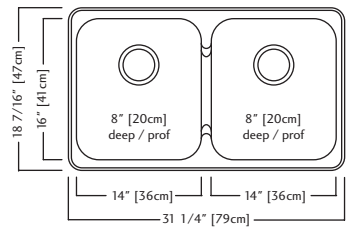

ACCESSORIES

- 1 Strainer Basket 1135 **2 Included**
3 Bottom Grid BG10S
5 Drainer Basket DBR10S
6 Bamboo Bridge Cutting Board 112.0654.749
7 Roller Mat RM55S



QDL2031-8-4 (4 faucet holes) \$745.00
101.0045.183

QDL2031-8-3 (3 faucet holes)
101.0045.182

QDL2031-8-1 (1 faucet hole)
101.0045.180



Outside Sink Rim Dimensions: 20 1/2" FB x 31 1/4" LR
Equal Size Bowl Dimensions: 16" FB x 14" LR x 8" DP
Minimum Cabinet Size: 33"
Gauge: 20
Corner Radius: 50mm
Finish: Satin Finished Bowls with Mirror Finished Rim
Drain Hole Location: Rear
Sound Dampening: Undercoating
Installation: Topmount / Drop In
Shipping Weight: 15.3 lbs

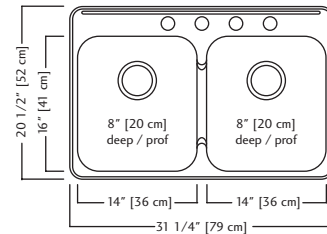

ACCESSORIES

- 1 Strainer Basket 1135 **2 Included**
3 Bottom Grid BG10S
5 Drainer Basket DBR10S
7 Roller Mat RM55S



QDL2031-7-4 (4 faucet holes) \$630.00
101.0045.178

QDL2031-7-3 (3 faucet holes)
101.0045.177

QDL2031-7-1 (1 faucet hole)
101.0045.176



Outside Sink Rim Dimensions: 20 1/2" FB x 31 1/4" LR
Equal Size Bowl Dimensions: 16" FB x 14" LR x 7" DP
Minimum Cabinet Size: 33"
Gauge: 20
Corner Radius: 50mm
Finish: Satin Finished Bowls with Mirror Finished Rim
Drain Hole Location: Rear
Sound Dampening: Undercoating
Installation: Topmount / Drop In
Shipping Weight: 15.9 lbs

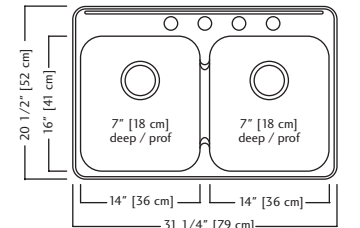

ACCESSORIES

- 1 Strainer Basket 1135 **2 Included**
3 Bottom Grid BG10S
5 Drainer Basket DBR10S
7 Roller Mat RM55S



QCMA1826-7-3 (3 faucet holes) \$710.00
101.0201.833

QCMA1826-7-1 (1 faucet hole)
101.0203.912



Outside Sink Rim Dimensions: 18 1/8" FB x 26 1/2" LR
Large Bowl Dimensions: 16" FB x 14" LR x 7" DP
Small Bowl Dimensions: 11 5/8" FB x 9 1/4" LR x 6" DP
Minimum Cabinet Size: 30"
Gauge: 20
Corner Radius: 50mm
Finish: Satin Finished Bowls with Mirror Finished Rim
Drain Hole Location: Rear
Sound Dampening: Undercoating
Installation: Topmount / Drop In
Shipping Weight: 12.8 lbs

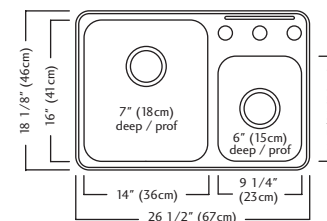

ACCESSORIES

- 1 Strainer Basket 1135 **2 Included**
3 Bottom Grid BG10S
5 Drainer Basket DBR10S
6 Bamboo Bridge Cutting Board 112.0654.749
7 Roller Mat RM55S



INCLUDED ACCESSORIES



1 Strainer Basket 1135
112.0040.566



2 Colander CA1W
112.0202.209
On select models as indicated

OPTIONAL ACCESSORIES

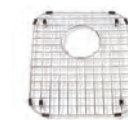

3 Bottom Grid BG10S
112.0044.785
\$185.00



4 Bottom Grid BG13S
112.0367.605
\$160.00



5 Drainer Basket DBR10S
112.0044.784
\$200.00



6 Bamboo Bridge Cutting Board 112.0654.749
\$210.00



7 Roller Mat RM55S
112.0058.824
\$245.00



STEEL QUEEN

Utility Sinks

BASIN BEAUTY

Count on Kindred for casual elegance in every room.

Our designers have dedicated decades to perfecting our stainless steel utility sinks, available in various sizes and styles that effortlessly complement any interior.

Balancing both resilience and elegance, our finishes endure the test of time and provide enduring cleanliness.



HIGHLY RESILIENT

Strong enough to take on life's messiest jobs with ease and is easy-to-clean and maintain.



ULTRA QUIET

Sound dampening system that keeps your kitchen clear of excess noise from running water and disposal vibration.



COMMERCIAL SATIN FINISH

Robust finished sinks stand up to heavy use while retaining their beauty for years.



Pictured: QSL1313-6-2



Pictured: QSL1719-8-3

QSLF2020-12-3 (3 faucet holes) \$1,485.00

101.0293.898

QSLF2020-12-1 (1 faucet hole)

101.0300.801



Outside Sink Rim Dimensions: 20 9/16" FB x 20 1/8" LR
Single Bowl Dimensions: 16" FB x 18" LR x 12" DP
Minimum Cabinet Size: 24"
Gauge: 18
Corner Radius: 25mm
Finish: Satin Finish
Drain Hole Location: Rear
Sound Dampening: Sound Pads & Undercoating
Installation: Dualmount
Shipping Weight: 32.3 lbs

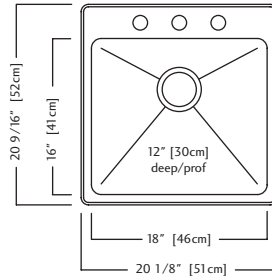

ACCESSORIES

- 1** Strainer Basket 1135 **Included**
4 Drainer Basket DBR10S
5 Roller Mat RM55S

QSLF2020-10-3 (3 faucet holes) \$1,295.00

101.0293.893

QSLF2020-10-1 (1 faucet hole)

101.0300.792



Outside Sink Rim Dimensions: 20 9/16" FB x 20 1/8" LR
Single Bowl Dimensions: 16" FB x 18" LR x 10" DP
Minimum Cabinet Size: 24"
Gauge: 18
Corner Radius: 25mm
Finish: Satin Finish
Drain Hole Location: Rear
Sound Dampening: Sound Pads & Undercoating
Installation: Dualmount
Shipping Weight: 29.9 lbs

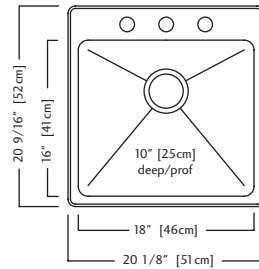

ACCESSORIES

- 1** Strainer Basket 1135 **Included**
4 Drainer Basket DBR10S
5 Roller Mat RM55S

QSL2225-12-3 (3 faucet holes) \$1,245.00

QSL2225-12-1 (1 faucet hole)

101.0689.150



Outside Sink Rim Dimensions: 22 1/16" FB x 25 5/8" LR
Single Bowl Dimensions: 17 1/2" FB x 23 1/2" LR x 12" DP
Minimum Cabinet Size: 27"
Gauge: 18
Corner Radius: 70mm
Finish: Satin Finished Bowl with Mirror Finished Rim
Drain Hole Location: Center
Sound Dampening: Undercoating
Installation: Topmount / Drop In
Shipping Weight: 20.4 lbs

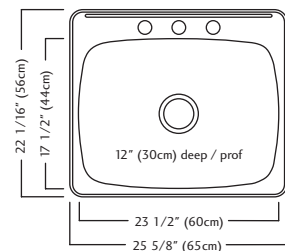

ACCESSORIES

- 1** Strainer Basket 1135 **Included**



QSLA2225-10-4 (4 faucet holes) \$1,070.00

101.0689.151

QSLA2225-10-3 (3 faucet holes)

101.0522.739

QSLA2225-10-1 (1 faucet hole)

101.0522.738



Outside Sink Rim Dimensions: 22" FB x 25 1/4" LR
Single Bowl Dimensions: 17" FB x 23" LR x 10" DP
Minimum Cabinet Size: 27"
Gauge: 18
Corner Radius: 50mm
Finish: Satin Finished Bowl with Mirror Finished Rim
Drain Hole Location: Rear
Sound Dampening: Undercoating
Installation: Topmount / Drop In
Shipping Weight: 17.5 lbs

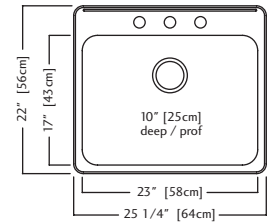

ACCESSORIES

- 1** Strainer Basket 1135 **Included**
2 Bottom Grid BGA2317S
5 Roller Mat RM55S



QSL2020-10-3 (3 faucet holes) \$785.00

113.0045.222

QSL2020-10-1 (1 faucet hole)

113.0045.221



Outside Sink Rim Dimensions: 20 9/16" FB x 20 1/8" LR
Single Bowl Dimensions: 16" FB x 18" LR x 10" DP
Minimum Cabinet Size: 24"
Gauge: 20
Corner Radius: 70mm
Finish: Satin Finished Bowl with Mirror Finished Rim
Drain Hole Location: Center
Sound Dampening: Undercoating
Installation: Topmount / Drop In
Shipping Weight: 14 lbs

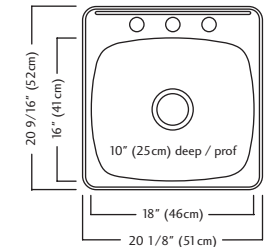

ACCESSORIES

- 1** Strainer Basket 1135 **Included**
3 Bottom Grid BG110S
5 Roller Mat RM55S



INCLUDED ACCESSORIES



- 1** Strainer Basket 1135
112.0040.566

OPTIONAL ACCESSORIES



- 2** Bottom Grid BGA2317S
112.0174.875
\$235.00



- 3** Bottom Grid BG110S
112.0040.526
\$235.00



- 4** Drainer Basket DBR10S
112.0044.784
\$200.00



- 5** Roller Mat RM55S
112.0058.824
\$245.00

QSU1820-10 \$770.00
122.0202.337



Outside Sink Rim Dimensions: 18 1/8" FB x 20 1/8" LR
Single Bowl Dimensions: 16" FB x 18" LR x 10" DP
Minimum Cabinet Size: 21"
Gauge: 20
Corner Radius: 70mm
Finish: Satin Finished Bowl with Satin Finished Rim
Drain Hole Location: Center
Sound Dampening: Undercoating
Installation: Undermount
Shipping Weight: 12.1 lbs

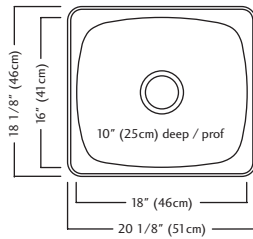

ACCESSORIES

- 1** Strainer Basket 1135 **Included**
2 Bottom Grid BG110S
3 Roller Mat RM55S

QS1820-10 \$760.00
101.0557.587



Outside Sink Rim Dimensions: 18 1/8" FB x 20 1/8" LR
Single Bowl Dimensions: 16" FB x 18" LR x 10" DP
Minimum Cabinet Size: 24"
Gauge: 20
Corner Radius: 70mm
Finish: Satin Finished Bowl with Mirror Finished Rim
Drain Hole Location: Center
Sound Dampening: Undercoating
Installation: Topmount / Drop In
Shipping Weight: 13.8 lbs

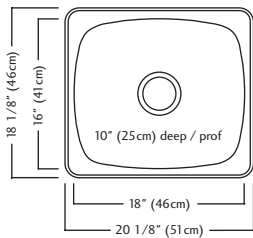

ACCESSORIES

- 1** Strainer Basket 1135 **Included**
2 Bottom Grid BG110S
3 Roller Mat RM55S



Pictured: QSL2020-10-1

RSL2020-10-3 (3 faucet holes) \$665.00
101.0255.448
RSL2020-10-1 (1 faucet hole)
101.0691.856



Outside Sink Rim Dimensions: 20 9/16" FB x 20 1/8" LR
Single Bowl Dimensions: 16" FB x 18" LR x 10" DP
Minimum Cabinet Size: 24"
Gauge: 20
Corner Radius: 70mm
Finish: Linear Brushed Bowl and Mirror Finished Rim
Drain Hole Location: Center
Sound Dampening: Sound Pads
Installation: Topmount / Drop In
Shipping Weight: 14.0 lbs

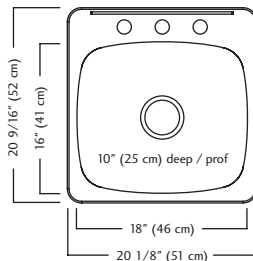

ACCESSORIES

- 1** Strainer Basket 1135 **Included**
2 Bottom Grid BG110S
3 Roller Mat RM55S



INCLUDED ACCESSORIES



- 1** Strainer Basket 1135
112.0040.566

OPTIONAL ACCESSORIES



- 2** Bottom Grid BG110S
112.0040.526
\$235.00



- 3** Roller Mat RM55S
112.0058.824
\$245.00

QSL1719-8-3 (3 faucet holes) \$480.00
101.0045.215

QSL1719-8-2 (2 faucet holes)
101.0045.214

QSL1719-8-1 (1 faucet hole)
101.0045.213



Outside Sink Rim Dimensions: 17" FB x 19 1/8" LR
Single Bowl Dimensions: 12" FB x 17" LR x 8" DP
Minimum Cabinet Size: 21"
Gauge: 20
Corner Radius: 70mm
Finish: Satin Finished Bowl with Mirror Finished Rim
Drain Hole Location: Center
Sound Dampening: Undercoating
Installation: Topmount / Drop In
Shipping Weight: 9 lbs

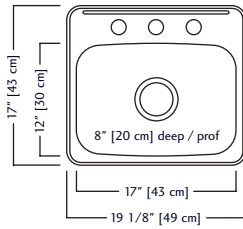

ACCESSORIES

- 1 Strainer Basket
1135
Included

QSL1313-6-2 (2 faucet holes) \$340.00
113.0045.208

QSL1313-6-1 (1 faucet hole)
113.0045.207



Outside Sink Rim Dimensions: 13 5/8" FB x 13 5/8" LR
Single Bowl Dimensions: 9 1/4" FB x 11 5/8" LR x 6" DP
Minimum Cabinet Size: 18"
Gauge: 20
Corner Radius: 50mm
Finish: Satin Finished Bowl with Mirror Finished Rim
Drain Hole Location: Center
Sound Dampening: Undercoating
Installation: Topmount / Drop In
Shipping Weight: 4.7 lbs

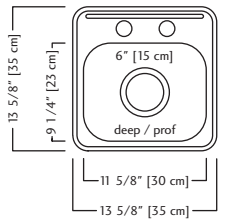

ACCESSORIES

- 1 Strainer Basket
1135
Included



QSL1515-6-2 (2 faucet holes) \$405.00
113.0045.211

QSL1515-6-1 (1 faucet hole)
113.0045.210



Outside Sink Rim Dimensions: 15 7/16" FB x 15 1/8" LR
Single Bowl Dimensions: 11" FB x 13" LR x 6" DP
Minimum Cabinet Size: 18"
Gauge: 20
Corner Radius: 50mm
Finish: Satin Finished Bowl with Mirror Finished Rim
Drain Hole Location: Center
Sound Dampening: Undercoating
Installation: Topmount / Drop In
Shipping Weight: 5.5 lbs

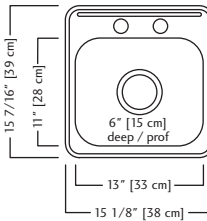

ACCESSORIES

- 1 Strainer Basket
1135
Included

QS1113-6 \$340.00
113.0045.193



Outside Sink Rim Dimensions: 11 1/4" FB x 13 5/8" LR
Single Bowl Dimensions: 9 1/4" FB x 11 5/8" LR x 6" DP
Minimum Cabinet Size: 18"
Gauge: 20
Corner Radius: 50mm
Finish: Satin Finished Bowl with Mirror Finished Rim
Drain Hole Location: Center
Sound Dampening: Undercoating
Installation: Topmount / Drop In
Shipping Weight: 5.0 lbs

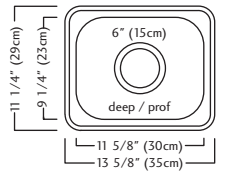

ACCESSORIES

- 1 Strainer Basket
1135
Included



QS1315-6 \$380.00
113.0045.194



Outside Sink Rim Dimensions: 13 1/8" FB x 15 1/8" LR
Single Bowl Dimensions: 11" FB x 13" LR x 6" DP
Minimum Cabinet Size: 18"
Gauge: 20
Corner Radius: 50mm
Finish: Satin Finished Bowl with Mirror Finished Rim
Drain Hole Location: Center
Sound Dampening: Undercoating
Installation: Topmount / Drop In
Shipping Weight: 5.6 lbs

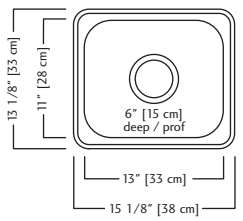

ACCESSORIES

- 1 Strainer Basket
1135
Included

INCLUDED ACCESSORIES



- 1 Strainer Basket
1135
112.0040.566

* ADA Compliant: Product is compliant with the American Disabilities Act when properly installed





Creemore

SINKS FOR REAL LIFE

Creemore Collection sinks were designed to make the daily grind less so.

With a complete range of features and styles that are easy-to-install and easy-to-maintain, they're sure to become easy to love by builders, installers, and homeowners alike. On selected models, real life meets real simplicity with the EZ Torque installation process, cutting time off the job with smart engineering.





CREEMORE

Topmount / Drop In Sinks

QUIET AS A WHISPER

With pioneering Whisper Steel sound dampening pads, Creemore topmount sinks make even the busiest bowls a pleasure to use.

Installation is as easy as a few simple steps with our streamlined fastener system designed to lock the sink securely to the countertop. Worry-free steel from the industry leader in stainless ensures that Creemore topmount sinks will retain their style for years to come.



EZ TORQUE INSTALLATION

Simplified fastener system and drop-and-drill process make this one of the industry's quickest sinks to install.



ULTRA QUIET

Sound dampening system that keeps your kitchen clear of excess noise from running water and disposal vibration.



SPACIOUS BOWL CAPACITY

Greater capacity than traditional tapered bowls.



Pictured: CDLA3322-8-3



Pictured: CSLA2522-7-1

CSLA1515-6-2CBN \$290.00
101.0651.328



Outside Sink Rim Dimensions: 15" FB x 15" LR
Single Bowl Dimensions: 11" FB x 13" LR x 6" DP
Minimum Cabinet Size: 18"
Gauge: 20
Corner Radius: 50mm
Finish: Satin Finish
Drain Hole Location: 2" Center
Sound Dampening: Sound Pads
Installation: Topmount / Drop In
Shipping Weight: 5.5 lbs

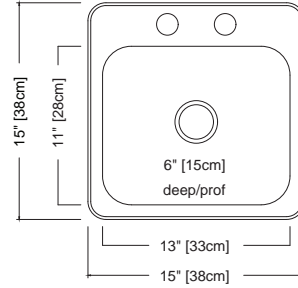

Strainer Not Included



CSLA2522-8-4CB (4 faucet holes) \$290.00
101.0637.051

CSLA2522-8-3CB (3 faucet holes)
101.0637.050

CSLA2522-8-1CB (1 faucet hole)
101.0637.049



Outside Sink Rim Dimensions: 22" FB x 25" LR
Single Bowl Dimensions: 17" FB x 23" LR x 8" DP
Minimum Cabinet Size: 27"
Gauge: 20
Corner Radius: 50mm
Finish: Satin Finish
Drain Hole Location: Rear
Sound Dampening: Sound Pads
Installation: Topmount / Drop In
Shipping Weight: 9.6 lbs

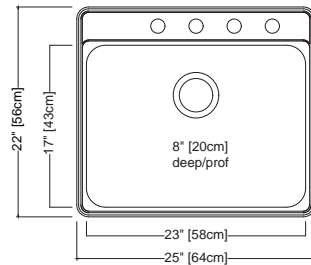

ACCESSORIES

- 1 Strainer Basket 2 Bottom Grid
- 4010856 BG2317R
- Included**



CSLA2522-7-4 (4 faucet holes) \$260.00
101.0637.048

CSLA2522-7-3 (3 faucet holes)
101.0637.047

CSLA2522-7-1 (1 faucet hole)
101.0637.046



Outside Sink Rim Dimensions: 22" FB x 25" LR
Single Bowl Dimensions: 17" FB x 23" LR x 7" DP
Minimum Cabinet Size: 27"
Gauge: 22
Corner Radius: 50mm
Finish: Satin Finish
Drain Hole Location: Center
Sound Dampening: Sound Pads
Installation: Topmount / Drop In
Shipping Weight: 8.6 lbs

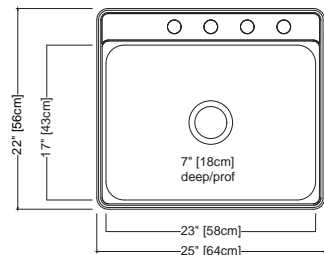

ACCESSORIES

- 1 Strainer Basket 3 Bottom Grid
- 4010856 BG2317C
- Included**



CSLA2522-6-4 (4 faucet holes) \$250.00
101.0637.045

CSLA2522-6-3 (3 faucet holes)
101.0637.044

CSLA2522-6-1 (1 faucet hole)
101.0637.043



Outside Sink Rim Dimensions: 22" FB x 25" LR
Single Bowl Dimensions: 17" FB x 23" LR x 6" DP
Minimum Cabinet Size: 27"
Gauge: 22
Corner Radius: 50mm
Finish: Satin Finish
Drain Hole Location: Center
Sound Dampening: Sound Pads
Installation: Topmount / Drop In
Shipping Weight: 7.6 lbs

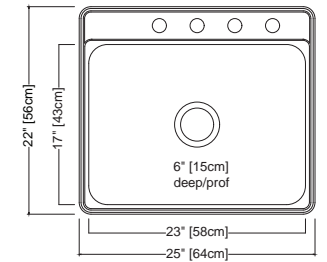

ACCESSORIES

- 1 Strainer Basket 3 Bottom Grid
- 4010856 BG2317C
- Included**



FCDLA3322-8-4CB (4 faucet holes) \$445.00
101.0652.631

FCDLA3322-8-3CB (3 faucet holes)
101.0637.053

FCDLA3322-8-1CB (1 faucet hole)
101.0637.052



Outside Sink Rim Dimensions: 22" FB x 33" LR
Equal Size Bowl Dimensions: 17" FB x 15" LR x 8" DP
Minimum Cabinet Size: 36"
Gauge: 18
Corner Radius: 50mm
Finish: Satin Finish
Drain Hole Location: Rear
Sound Dampening: Sound Pads
Installation: Topmount / Drop In
Shipping Weight: 17.2 lbs

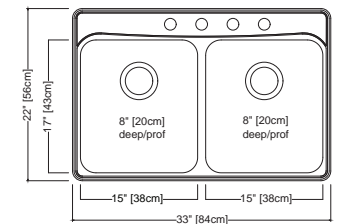

ACCESSORIES

- 1 Strainer Basket 4 Bottom Grid 5 Bamboo Bridge
- 4010856 BG1715R Cutting Board
- 2 **Included** 112.0654.749



INCLUDED ACCESSORIES



- 1 Strainer Basket
- 4010856
- 112.0083.598

OPTIONAL ACCESSORIES



- 2 Bottom Grid
- BG2317R
- 112.0611.550
- \$100.00



- 3 Bottom Grid
- BG2317C
- 112.0611.545
- \$100.00



- 4 Bottom Grid
- BG1715R
- 112.0611.548
- \$85.00



- 5 Bamboo Bridge
- Cutting Board
- 112.0654.749
- \$210.00

* ADA Compliant: Product is compliant with the American Disabilities Act when properly installed &

CDLA3322-8-4CB (4 faucet holes) \$400.00

101.0637.042

CDLA3322-8-3CB (3 faucet holes)

101.0637.041

CDLA3322-8-1CB (1 faucet hole)

101.0637.040



Outside Sink Rim Dimensions: 22" FB x 33" LR
 Equal Size Bowl Dimensions: 17" FB x 15" LR x 8" DP
 Minimum Cabinet Size: 36"
 Gauge: 20
 Corner Radius: 50mm
 Finish: Satin Finish
 Drain Hole Location: Rear
 Sound Dampening: Sound Pads
 Installation: Topmount / Drop In
 Shipping Weight: 17.2 lbs

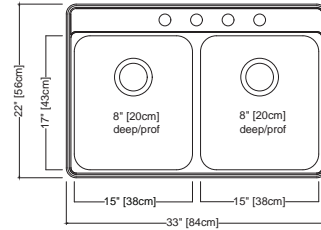

ACCESSORIES

- 1 Strainer Basket 4010856 **2 Included**
- 2 Bottom Grid BG1715R
- 4 Bamboo Bridge Cutting Board 112.0654.749



RDLA3319-6-4CB \$310.00

101.0689.157



Outside Sink Rim Dimensions: 18 5/16" FB x 32 15/16" LR
 Equal Bowl Dimensions: 14" FB x 14" LR x 6" DP
 Minimum Cabinet Size: 36"
 Gauge: 22
 Corner Radius: 90mm
 Finish: Satin Finish
 Drain Hole Location: Rear
 Sound Dampening: Sound Pads
 Installation: Topmount / Drop In
 Shipping Weight: 13.0 lbs

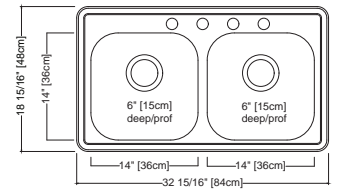

ACCESSORIES

- 1 Strainer Basket 4010856 **2 Included**
- 4 Bamboo Bridge Cutting Board 112.0654.749



CDLA3322-7-4 (4 faucet holes) \$345.00

101.0637.039

CDLA3322-7-3 (3 faucet holes)

101.0637.038

CDLA3322-7-1 (1 faucet hole)

101.0637.037



Outside Sink Rim Dimensions: 22" FB x 33" LR
 Equal Bowl Dimensions: 17" FB x 15" LR x 7" DP
 Minimum Cabinet Size: 36"
 Gauge: 22
 Corner Radius: 50mm
 Finish: Satin Finish
 Drain Hole Location: Center
 Sound Dampening: Sound Pads
 Installation: Topmount / Drop In
 Shipping Weight: 14.5 lbs

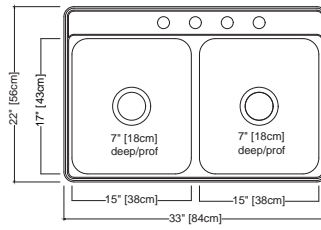

ACCESSORIES

- 1 Strainer Basket 4010856 **2 Included**
- 3 Bottom Grid BG1715C
- 4 Bamboo Bridge Cutting Board 112.0654.749



CDLA3322-6-4 (4 faucet holes) \$335.00

101.0637.036

CDLA3322-6-3 (3 faucet holes)

101.0637.035

CDLA3322-6-1 (1 faucet hole)

101.0637.034



Outside Sink Rim Dimensions: 22" FB x 33" LR
 Equal Bowl Dimensions: 17" FB x 15" LR x 6" DP
 Minimum Cabinet Size: 36"
 Gauge: 22
 Corner Radius: 50mm
 Finish: Satin Finish
 Drain Hole Location: Center
 Sound Dampening: Sound Pads
 Installation: Topmount / Drop In
 Shipping Weight: 13.5 lbs

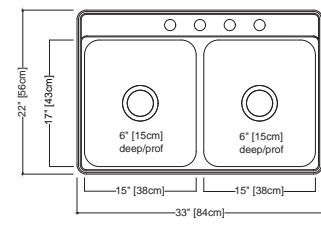

ACCESSORIES

- 1 Strainer Basket 4010856 **2 Included**
- 3 Bottom Grid BG1715C
- 4 Bamboo Bridge Cutting Board 112.0654.749



INCLUDED ACCESSORIES



- 1 Strainer Basket 4010856 112.0083.598

OPTIONAL ACCESSORIES



- 2 Bottom Grid BG1715R 112.0611.548 \$85.00



- 3 Bottom Grid BG1715C 112.0611.546 \$85.00



- 4 Bamboo Bridge Cutting Board 112.0654.749 \$210.00

* ADA Compliant: Product is compliant with the American Disabilities Act when properly installed



Reginox

PARAMOUNT SELECTION

The Reginox Collection brings exceptional value that will stand up to everyday chores.

Versatile in form and function, Kindred Reginox sinks offer exceptional value and selection — all backed with a Limited Lifetime manufacturer's warranty.





REGINOX

Undermount Sinks

A SINK FOR ANY SPACE

One size does not fit all- especially where sinks are concerned. Reginox sinks come in sizes and configurations to fit any room in the house.

Kindred's versatile undermount sinks are designed to sit under any solid surface counter, creating a seamless profile that introduces a sleek style to any room.



UNDERMOUNT INSTALLATION

Seamless profile brings sleek style to any kitchen.



EASY TO CLEAN

Gently sloping corners make cleaning a breeze and add a soft touch to any room.



EASY CARE STAINLESS

Sturdy 20-18 gauge steel from the industry leader in stainless, with a finish that will stand up to hard work, year in and year out.



Pictured: RSU1820-7



Pictured: NDC1827RU-9

NS1930U-9 \$510.00
122.0264.716



Outside Sink Rim Dimensions: 18 3/4" FB x 29 3/4" LR
Single Bowl Dimensions: 17" FB x 28" LR x 8 1/2" DP
Minimum Cabinet Size: 33"
Gauge: 18
Corner Radius: 70mm
Finish: Linear Brushed Bowl with Silk Finished Rim
Drain Hole Location: Rear
Sound Dampening: Undercoating
Installation: Undermount
Shipping Weight: 18.4 lbs

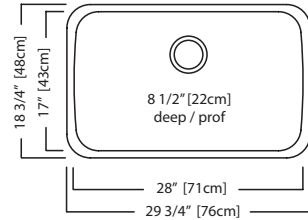

ACCESSORIES

- 1** Strainer Basket 1135 **Included**
- 2** Bottom Grid BG90S
- 5** Drainer Basket DBR10S
- 7** Bamboo Bridge Cutting Board 112.0654.749

NS1925U-9 \$415.00
122.0264.715



Outside Sink Rim Dimensions: 18 3/4" FB x 24 3/4" LR
Single Bowl Dimensions: 17" FB x 23" LR x 8 1/2" DP
Minimum Cabinet Size: 27"
Gauge: 18
Corner Radius: 70mm
Finish: Linear Brushed Bowl with Silk Finished Rim
Drain Hole Location: Rear
Sound Dampening: Undercoating
Installation: Undermount
Shipping Weight: 15.3 lbs

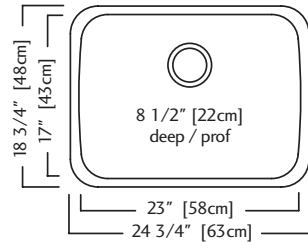

ACCESSORIES

- 1** Strainer Basket 1135 **Included**
- 3** Bottom Grid BG80S
- 5** Drainer Basket DBR10S
- 7** Bamboo Bridge Cutting Board 112.0654.749

NS1820UA-9 \$395.00
122.0523.289



Outside Sink Rim Dimensions: 17 3/4" FB x 19 3/4" LR
Single Bowl Dimensions: 16" FB x 18" LR x 8 1/2" DP
Minimum Cabinet Size: 21"
Gauge: 18
Corner Radius: 70mm
Finish: Linear Brushed Bowl with Silk Finished Rim
Drain Hole Location: Rear
Sound Dampening: Undercoating
Installation: Undermount
Shipping Weight: 11.9 lbs

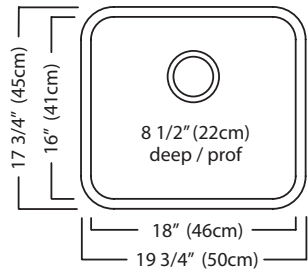

ACCESSORIES

- 1** Strainer Basket 1135 **Included**
- 4** Bottom Grid BG11S
- 7** Bamboo Bridge Cutting Board 112.0654.749
- 8** Roller Mat RM55S

RSU1820-7 \$300.00
122.0483.903



Outside Sink Rim Dimensions: 17 3/4" FB x 19 3/4" LR
Single Bowl Dimensions: 16" FB x 18" LR x 7" DP
Minimum Cabinet Size: 21"
Gauge: 20
Corner Radius: 70mm
Finish: Linear Brushed Bowl with Silk Finished Rim
Drain Hole Location: Rear
Sound Dampening: Sound Pads
Installation: Undermount
Shipping Weight: 7.9 lbs

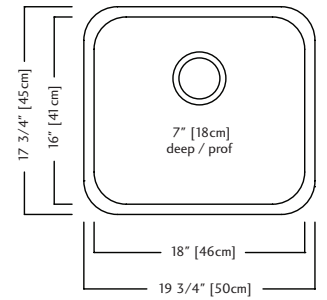

ACCESSORIES

- 1** Strainer Basket 1135 **Included**
- 4** Bottom Grid BG11S
- 7** Bamboo Bridge Cutting Board 112.0654.749
- 8** Roller Mat RM55S

NS1813U-7 \$260.00
122.0264.714



Outside Sink Rim Dimensions: 18 1/8" FB x 12 3/8" LR
Single Bowl Dimensions: 16" FB x 10 5/8" LR x 7" DP
Minimum Cabinet Size: 15"
Gauge: 18
Corner Radius: 89mm
Finish: Linear Brushed Bowl with Silk Finished Rim
Drain Hole Location: Rear
Sound Dampening: Undercoating
Installation: Undermount
Shipping Weight: 7.0 lbs

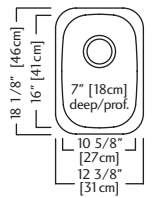

ACCESSORIES

- 1** Strainer Basket 1135 **Included**
- 6** Bottom Grid BG35S

INCLUDED ACCESSORIES



- 1** Strainer Basket 1135 112.0040.566

OPTIONAL ACCESSORIES



- 2** Bottom Grid BG90S 112.0044.794 \$235.00



- 3** Bottom Grid BG80S 112.0044.793 \$225.00

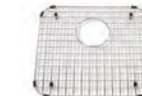

- 4** Bottom Grid BG11S 112.0044.786 \$175.00



- 5** Drainer Basket DBR10S 112.0044.784 \$200.00



- 6** Bottom Grid BG35S 112.0044.796 \$190.00



- 7** Bamboo Bridge Cutting Board 112.0654.749 \$210.00



- 8** Roller Mat RM55S 112.0058.824 \$245.00

ND1831UA-9 \$610.00
122.0523.305



Outside Sink Rim Dimensions: 17 3/4" FB x 30 7/8" LR
Equal Size Bowl Dimensions: 16" FB x 14" LR x 8 1/2" DP
Minimum Cabinet Size: 33"
Gauge: 18
Corner Radius: 50mm
Finish: Linear Brushed Bowl with Silk Finished Rim
Drain Hole Location: Rear
Sound Dampening: Undercoating
Installation: Undermount
Shipping Weight: 18.8 lbs

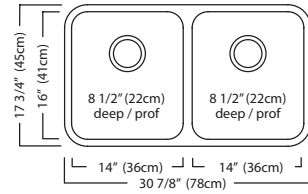

ACCESSORIES

- 1** Strainer Basket 1135 **2** Bottom Grid BG10S **4** Drainer Basket DBR10S **5** Bamboo Bridge Cutting Board 112.0654.749 **6** Roller Mat RM55S
- 2 Included**

NDC1827RU-9 \$520.00



Outside Sink Rim Dimensions: 17 3/4" FB x 26 7/8" LR
Large Bowl Dimensions: 16" FB x 14" LR x 8 1/2" DP
Small Bowl Dimensions: 16" FB x 10" LR x 7" DP
Minimum Cabinet Size: 30"
Gauge: 18
Corner Radius: 70mm
Finish: Linear Brushed Bowl with Silk Finished Rim
Drain Hole Location: Rear
Sound Dampening: Undercoating
Installation: Undermount
Shipping Weight: 15.6 lbs

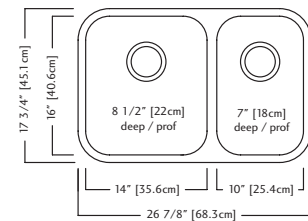

ACCESSORIES

- 1** Strainer Basket 1135 **2** Bottom Grid BG10S **3** Bottom Grid BG13S **4** Drainer Basket DBR10S **5** Bamboo Bridge Cutting Board 112.0654.749 **6** Roller Mat RM55S
- 2 Included**

RDU1831-7 \$370.00
122.0391.891



Outside Sink Rim Dimensions: 17 3/4" FB x 30 7/8" LR
Equal size Bowl Dimensions: 16" FB x 14" LR x 7" DP
Minimum Cabinet Size: 33"
Gauge: 20
Corner Radius: 70mm
Finish: Linear Brushed Bowl with Silk Finished Rim
Drain Hole Location: Rear
Sound Dampening: Sound Pads
Installation: Undermount
Shipping Weight: 12.5 lbs

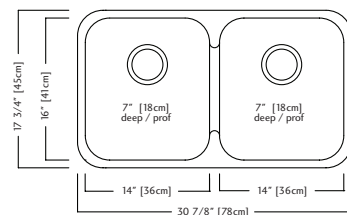

ACCESSORIES

- 1** Strainer Basket 1135 **2** Bottom Grid BG10S **4** Drainer Basket DBR10S **5** Bamboo Bridge Cutting Board 112.0654.749 **6** Roller Mat RM55S
- 2 Included**



INCLUDED ACCESSORIES



- 1** Strainer Basket 1135
112.0040.566

OPTIONAL ACCESSORIES

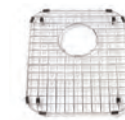

- 2** Bottom Grid BG10S
112.0044.785
\$185.00

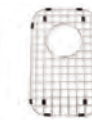

- 3** Bottom Grid BG13S
112.0367.605
\$160.00



- 4** Drainer Basket DBR10S
112.0044.784
\$200.00



- 5** Bamboo Bridge Cutting Board
112.0654.749
\$210.00



- 6** Roller Mat RM55S
112.0058.824
\$245.00



REGINOX

Topmount / Drop In Sinks

NO HASSLE INSTALLATION

Update your home's kitchen with a versatile sink from the Reginox Collection.

These drop in sinks come in a variety of configurations that seamlessly blend style and practicality, ensuring there's a model to meet every specific requirement.

Easy-to-install, this topmount line includes large capacity models. Upgrade your cleaning power with a Reginox topmount.



TOPMOUNT / DROP IN INSTALLATION

A favorite for quick kitchen upgrades due to ease of installation and versatility of placement.



BRILLIANT FINISH

Pre-finished to a glowing, hygienic, and easy-to-clean finish.



EZ TORQUE INSTALLATION

Simplified fastener system and drop-and-drill process make this one of the industry's quickest sinks to install.



Pictured: RCL2027R-1



Pictured: RDL2031-3

RSL5251-3 (3 faucet holes) \$280.00
101.0045.305

RSL5251-1 (1 faucet hole)
101.0045.304



Outside Sink Rim Dimensions: 20 9/16" FB x 20 1/8" LR
Single Bowl Dimensions: 16" FB x 18" LR x 7" DP
Minimum Cabinet Size: 24"
Gauge: 20
Corner Radius: 70mm
Finish: Linear Brushed Bowl and Mirror Finished Rim
Drain Hole Location: Center
Sound Dampening: Sound Pads
Installation: Topmount / Drop In
Shipping Weight: 9.4 lbs

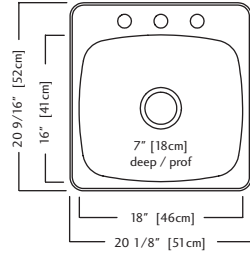

ACCESSORIES

- 2** Strainer Basket 1140 **3** Bottom Grid BG110S
Included



RSL2020-3 (3 faucet holes) \$270.00
101.0045.302

RSL2020-1 (1 faucet hole)
101.0045.301



Outside Sink Rim Dimensions: 20 9/16" FB x 20 1/8" LR
Single Bowl Dimensions: 16" FB x 18" LR x 7" DP
Minimum Cabinet Size: 24"
Gauge: 20
Corner Radius: 70mm
Finish: Linear Brushed Bowl and Mirror Finished Rim
Drain Hole Location: Center
Sound Dampening: Sound Pads
Installation: Topmount / Drop In
Shipping Weight: 9.0 lbs

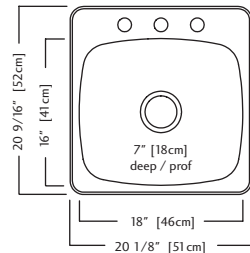

ACCESSORIES

- 1** Strainer Basket 1135 **3** Bottom Grid BG110S
Included



RCL2027R-3 (3 faucet holes) \$490.00
101.0045.284

RCL2027R-1 (1 faucet hole)
101.0045.283



Outside Sink Rim Dimensions: 20 9/16" FB x 27 1/4" LR
Large Bowl Dimensions: 16" FB x 14" LR x 7" DP
Small Bowl Dimensions: 16" FB x 10" LR x 7" DP
Minimum Cabinet Size: 30"
Gauge: 20
Corner Radius: 70mm
Finish: Linear Brushed Bowl and Mirror Finished Rim
Drain Hole Location: Rear
Sound Dampening: Sound Pads
Installation: Topmount / Drop In
Shipping Weight: 13.9 lbs

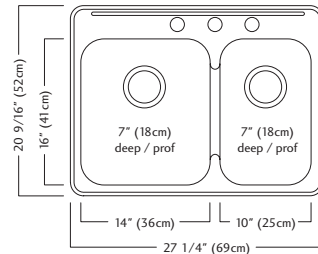

ACCESSORIES

- 1** Strainer Basket 1135 **4** Bottom Grid BG10S **5** Drainer Basket DBR10S **6** Roller Mat RM55S
2 Included



RDL5279-4 (4 faucet holes) \$480.00
101.0045.299

RDL5279-3 (3 faucet holes)
101.0045.298

RDL5279-1 (1 faucet hole)
101.0045.297



Outside Sink Rim Dimensions: 20 1/2" FB x 31 1/4" LR
Equal size Bowl Dimensions: 16" FB x 14" LR x 7" DP
Minimum Cabinet Size: 33"
Gauge: 20
Corner Radius: 70mm
Finish: Linear Brushed Bowl and Mirror Finished Rim
Drain Hole Location: Rear
Sound Dampening: Sound Pads
Installation: Topmount / Drop In
Shipping Weight: 16.8 lbs

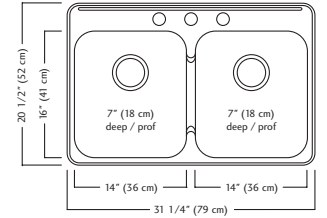

ACCESSORIES

- 2** Strainer Basket 1140 **4** Bottom Grid BG10S **5** Drainer Basket DBR10S **6** Roller Mat RM55S
2 Included



RDL2031-3 (3 faucet holes) \$465.00
101.0045.295

RDL2031-1 (1 faucet hole)
101.0045.294



Outside Sink Rim Dimensions: 20 1/2" FB x 31 1/4" LR
Equal size Bowl Dimensions: 16" FB x 14" LR x 7" DP
Minimum Cabinet Size: 33"
Gauge: 20
Corner Radius: 70mm
Finish: Linear Brushed Bowl and Mirror Finished Rim
Drain Hole Location: Rear
Sound Dampening: Sound Pads
Installation: Topmount / Drop In
Shipping Weight: 14.8 lbs

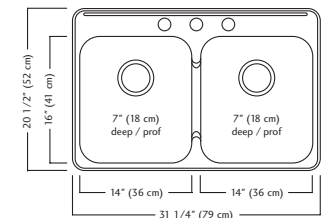

ACCESSORIES

- 1** Strainer Basket 1135 **4** Bottom Grid BG10S **5** Drainer Basket DBR10S **6** Roller Mat RM55S
2 Included



INCLUDED ACCESSORIES



1 Strainer Basket 1135
112.0040.566



2 Strainer Basket 1140
112.0373.732

OPTIONAL ACCESSORIES

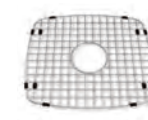

3 Bottom Grid BG110S
112.0040.526
\$235.00



5 Drainer Basket DBR10S
112.0044.784
\$200.00

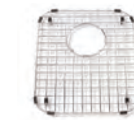

4 Bottom Grid BG10S
112.0044.785
\$185.00



6 Roller Mat RM55S
112.0058.824
\$245.00



REGINOX

ADA Sinks

FUNCTIONAL DESIGN

Made to work with easy-to-clean corners, resilient finish, and sound dampening system, these sinks pair perfectly in traditional, contemporary, or transitional kitchen designs.

Offered in an assortment of configurations and installation options, Reginox ADA sinks deliver functional design for everyone without sacrificing quality or style.



ACCESSIBLE DESIGN

Shallow bowl depth and rear drain placement allows for sufficient knee space when sink is used in seated position.



BRILLIANT FINISH

Finished to a glowing, hygienic, and easy-to-clean satin finish.



EASY CARE STAINLESS

Sturdy 18 gauge steel from the industry leader in stainless, with a finish that will stand up to hard work, year in and year out.



Pictured: RDLA3322-55-1



Pictured: RSU1829-55

RSU1829-55 \$580.00
122.0641.407



Outside Sink Rim Dimensions: 18 3/4" FB x 29 3/4" LR
Single Bowl Dimensions: 17" FB x 28" LR x 5 1/2" DP
Minimum Cabinet Size: 33"
Gauge: 18
Corner Radius: 70mm
Finish: Satin Finish
Drain Hole Location: Rear
Sound Dampening: Sound Pads
Installation: Undermount
Shipping Weight: 20 lbs
ADA Compliant

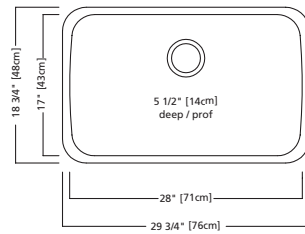

ACCESSORIES

- 1 Strainer Basket 1135 **Included**
- 2 Bamboo Bridge Cutting Board 112.0654.749



RSU1925-55 \$490.00
122.0641.408



Outside Sink Rim Dimensions: 18 3/4" FB x 24 3/4" LR
Single Bowl Dimensions: 17" FB x 23" LR x 5 1/2" DP
Minimum Cabinet Size: 27"
Gauge: 18
Corner Radius: 70mm
Finish: Satin Finish
Drain Hole Location: Rear
Sound Dampening: Sound Pads
Installation: Undermount
Shipping Weight: 15 lbs
ADA Compliant

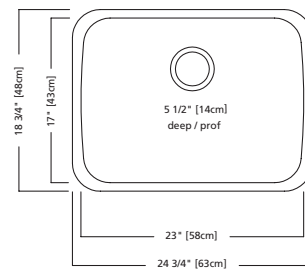

ACCESSORIES

- 1 Strainer Basket 1135 **Included**
- 2 Bamboo Bridge Cutting Board 112.0654.749



RSLA2522-55-4 (4 faucet holes) \$580.00
101.0643.199

RSLA2522-55-3 (3 faucet holes)
101.0643.198

RSLA2522-55-1 (1 faucet hole)
101.0643.197



Outside Sink Rim Dimensions: 22" FB x 25 5/8" LR
Single Bowl Dimensions: 17" FB x 23" LR x 5 1/2" DP
Minimum Cabinet Size: 27"
Gauge: 18
Corner Radius: 70mm
Finish: Satin Finish
Drain Hole Location: Rear
Sound Dampening: Sound Pads
Installation: Topmount / Drop In
Shipping Weight: 16 lbs
ADA Compliant

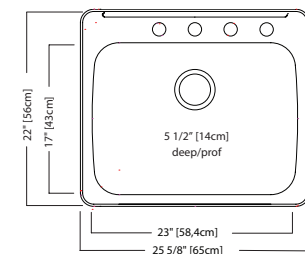

ACCESSORIES

- 2 Strainer Basket 1135 **Included**



RDLA3322-55-4 (4 faucet holes) \$695.00
101.0643.196

RDLA3322-55-3 (3 faucet holes)
101.0643.195

RDLA3322-55-1 (1 faucet hole)
101.0634.002



Outside Sink Rim Dimensions: 22" FB x 33 1/4" LR
Equal Bowl Dimensions: 17" FB x 15" LR x 5 1/2" DP
Minimum Cabinet Size: 36"
Gauge: 18
Corner Radius: 70mm
Finish: Satin Finish
Drain Hole Location: Rear
Sound Dampening: Sound Pads
Installation: Topmount / Drop In
Shipping Weight: 20.7 lbs
ADA Compliant

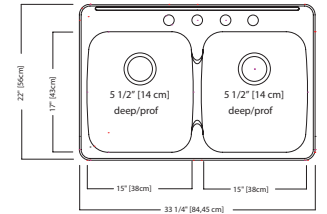

ACCESSORIES

- 1 Strainer Basket 1135 **2 Included**



INCLUDED ACCESSORIES



- 1 Strainer Basket 1135 112.0040.566



- 2 Bamboo Bridge Cutting Board 112.0654.749 \$210.00

* ADA Compliant: Product is compliant with the American Disabilities Act when properly installed



Urban Granite

WARM UP THE KITCHEN WITH GRANITE

A blend of ultra-modern design and durability, the Urban Granite Collection is perfect for today's home chef.

Made of granite, a blend of quartz and acrylic resin, these sinks are packed full of hidden design features that are made to maintain your granite sink's beauty for years to come. With the reliability guaranteed by the Kindred Crown, our granite sinks impart rich elegance in several sumptuous shades.

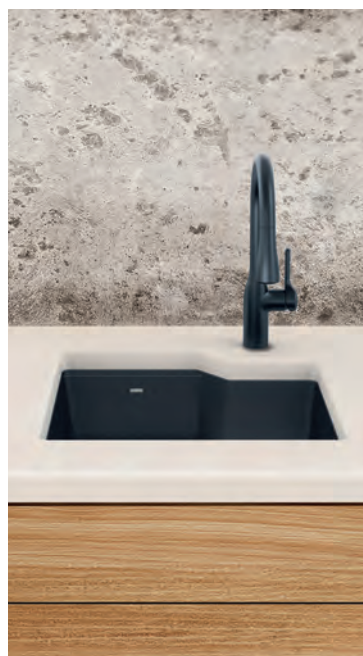



URBAN GRANITE

Undermount Sinks

NATURALLY UNDERSTATED

When a kitchen calls for a softer look than stainless, granite is the natural choice. Our Urban Granite pairs natural warmth and hard-working innovation.

Crafted for durability with Kindred's patented DuraKleen technology, our granite sinks resist stains and stand up to temperatures as high as 536°F / 280°C. Sanitized® technology makes sink surfaces resistant to microbial and bacterial growth. This means the finish repels most stains like wine, coffee, and grease.



COLORFAST PROTECTION

UV Protection ensures that these beauties maintain their natural tones for years.



SANITIZED® HYGIENE FUNCTION

Helps control bacterial odor and microbial growth.



SCRATCH RESISTANT

Made from high quality quartz and acrylic resin that makes the sink incredibly robust and hard wearing.



Pictured: MGC2034U-95G



Pictured: MGC2031U-9MBK

MGS2031U-9 \$835.00



MGS2031U-9PWT Polar White	125.0637.135
MGS2031U-9SG Stone Grey	125.0641.545
NEW MGS2031U-9SLG Slate Grey	125.0713.142
MGS2031U-9ON Onyx	125.0641.544
MGS2031U-9MBK Matte Black	125.0637.129
MGS2031U-9CHA Champagne	125.0637.125
MGS2031U-9ES Mocha	125.0641.543

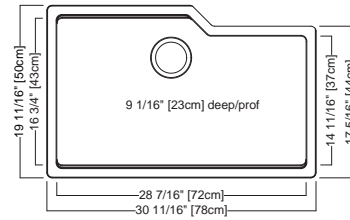

Outside Sink Rim Dimensions: 19 11/16" FB x 30 11/16" LR
 Single Bowl Dimensions: 16 3/4" FB x 28 7/16" LR X 9 1/16" DP
 Minimum Cabinet Size: 33"
 Corner Radius: 15mm
 Drain Hole Location: Rear
 Installation: Undermount
 Shipping Weight: 33.0 lbs

ACCESSORIES

- 1** Strainer Basket 1135 **Included**
- 5** Bottom Grid BG410S
- 7** Cutting Board BB10
- 8** Colander C417P

MGS2022U-9 \$730.00



MGS2022U-9PWT Polar White	125.0637.132
MGS2022U-9SG Stone Grey	125.0641.541
NEW MGS2022U-9SLG Slate Grey	125.0713.140
MGS2022U-9ON Onyx	125.0641.540
MGS2022U-9MBK Matte Black	125.0637.128
MGS2022U-9CHA Champagne	125.0637.124
MGS2022U-9ES Mocha	125.0641.539

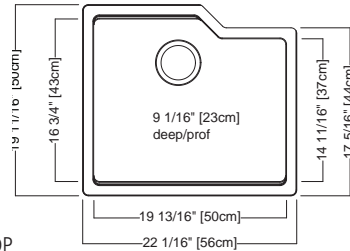

Outside Sink Rim Dimensions: 19 11/16" FB x 22 1/16" LR
 Single Bowl Dimensions: 16 3/4" FB x 19 13/16" LR X 9 1/16" DP
 Minimum Cabinet Size: 24"
 Corner Radius: 15mm
 Drain Hole Location: Rear
 Installation: Undermount
 Shipping Weight: 25.0 lbs

ACCESSORIES

- 1** Strainer Basket 1135 **Included**
- 6** Bottom Grid BG400S
- 7** Cutting Board BB10
- 8** Colander C417P

MGC2034U-9 \$900.00



MGC2034U-9PWT Polar White	125.0637.134
MGC2034U-9SG Stone Grey	125.0641.537
NEW MGC2034U-9SLG Slate Grey	125.0713.146
MGC2034U-9ON Onyx	125.0641.536
MGC2034U-9MBK Matte Black	125.0637.131
MGC2034U-9CHA Champagne	125.0637.127
MGC2034U-9ES Mocha	125.0641.535

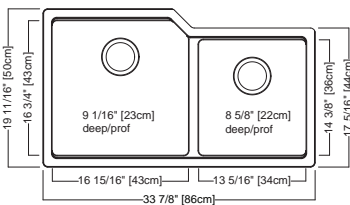

Outside Sink Rim Dimensions: 19 11/16" FB x 33 7/8" LR
 Large Bowl Dimensions: 16 3/4" FB x 16 15/16" LR x 9 1/16" DP
 Small Bowl Dimensions: 14 3/8" FB x 13 5/16" LR x 8 5/8" DP
 Minimum Cabinet Size: 36"
 Corner Radius: 15mm
 Drain Hole Location: Rear
 Installation: Undermount
 Shipping Weight: 40.0 lbs

ACCESSORIES

- 1** Strainer Basket 1135 **2 Included**
- 2** Bottom Grid BG450S
- 3** Bottom Grid BG440S
- 7** Cutting Board BB10
- 8** Colander C417P

MGC2031U-9 \$870.00



MGC2031U-9PWT Polar White	125.0637.133
MGC2031U-9SG Stone Grey	125.0641.533
NEW MGC2031U-9SLG Slate Grey	125.0713.144
MGC2031U-9ON Onyx	125.0641.532
MGC2031U-9MBK Matte Black	125.0637.130
MGC2031U-9CHA Champagne	125.0637.126
MGC2031U-9ES Mocha	125.0641.531

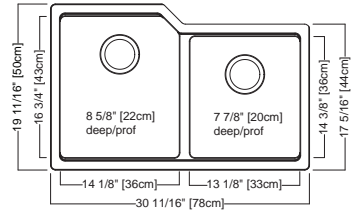

Outside Sink Rim Dimensions: 19 11/16" FB x 30 11/16" LR
 Large Bowl Dimensions: 16 3/4" FB x 14 1/8" LR x 8 5/8" DP
 Small Bowl Dimensions: 14 3/8" FB x 13 1/8" LR x 7 7/8" DP
 Minimum Cabinet Size: 33"
 Corner Radius: 15mm
 Drain Hole Location: Rear
 Installation: Undermount
 Shipping Weight: 35.0 lbs

ACCESSORIES

- 1** Strainer Basket 1135 **2 Included**
- 4** Bottom Grid BG430S
- 3** Bottom Grid BG440S
- 7** Cutting Board BB10
- 8** Colander C417P

INCLUDED ACCESSORIES



- 1** Strainer Basket 1135 112.0040.566

OPTIONAL ACCESSORIES



- 2** Bottom Grid BG450S 112.0632.200 \$195.00
- 3** Bottom Grid BG440S 112.0632.198 \$155.00
- 4** Bottom Grid BG430S 112.0632.199 \$170.00
- 5** Bottom Grid BG410S 112.0632.196 \$270.00



- 6** Bottom Grid BG400S 112.0632.197 \$185.00
- 7** Cutting Board BB10 112.0644.464 \$225.00
- 8** Colander C417P 112.0538.950 \$100.00



URBAN GRANITE

Topmount / Drop In Sinks

EARTHY ELEGANCE

Natural textures and earth tones of Kindred Granite sinks will elevate your kitchen to match any contemporary or organic modern inspired style.

These sinks are crafted for maximum function. Their naturally sound-absorbing materials minimize noise and vibration, while a non-porous Sanitized® finish keeps germs away.

With reliability guaranteed by our Kindred Crown, these granite sinks impart a rich elegance in several sophisticated shades.



HEAT RESISTANT

Strong enough to withstand hot pans straight from the oven due to heat and thermal shock resistance.



DURAKLEEN

The smooth granite finish repels all stains like wine, coffee and grease. Cleans easily with soapy water.



SANITIZED® HYGIENE FUNCTION

Helps control bacterial odor and microbial growth.



Pictured: MGSM2022-9SG



*Urban Granite
Topmount / Drop In*

Pictured: MGCM2031-9ON

MGSM2031-9 \$795.00

(3 pre-scored faucet holes)



MGSM2031-9PWT Polar White	114.0637.983
MGSM2031-9SG Stone Grey	114.0643.400
NEW MGSM2031-9SLG Slate Grey	114.0713.134
MGSM2031-9ON Onyx	114.0643.399
MGSM2031-9MBK Matte Black	114.0637.977
MGSM2031-9CHA Champagne	114.0637.969
MGSM2031-9ES Mocha	114.0643.398

Outside Sink Rim Dimensions: 19 11/16" FB X 30 11/16" LR
 Single Bowl Dimensions: 16 3/4" FB x 28 7/16" LR x 9 1/16" DP
 Minimum Cabinet Size: 33"
 Corner Radius: 15mm
 Drain Hole Location: Rear
 Installation: Topmount / Drop In
 Shipping Weight: 36.5 lbs

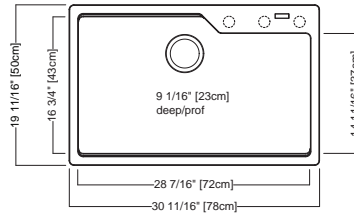

ACCESSORIES

- | | | | |
|---|--------------------------------|--------------------------------|----------------------------|
| 1 Strainer Basket
1135
Included | 5 Bottom Grid
BG410S | 7 Cutting Board
BB10 | 8 Colander
C417P |
|---|--------------------------------|--------------------------------|----------------------------|

MGSM2022-9 \$690.00

(2 pre-scored faucet holes)



MGSM2022-9PWT Polar White	114.0643.395
MGSM2022-9SG Stone Grey	114.0643.396
NEW MGSM2022-9SLG Slate Grey	114.0713.132
MGSM2022-9ON Onyx	114.0643.394
MGSM2022-9MBK Matte Black	114.0637.976
MGSM2022-9CHA Champagne	114.0637.968
MGSM2022-9ES Mocha	114.0643.393

Outside Sink Rim Dimensions: 19 11/16" FB X 22 1/16" LR
 Single Bowl Dimensions: 16 3/4" FB x 19 13/16" LR x 9 1/16" DP
 Minimum Cabinet Size: 24"
 Corner Radius: 15mm
 Drain Hole Location: Rear
 Installation: Topmount / Drop In
 Shipping Weight: 27.0 lbs

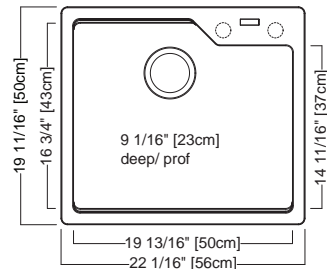

ACCESSORIES

- | | | | |
|---|--------------------------------|--------------------------------|----------------------------|
| 1 Strainer Basket
1135
Included | 6 Bottom Grid
BG400S | 7 Cutting Board
BB10 | 8 Colander
C417P |
|---|--------------------------------|--------------------------------|----------------------------|

MGCM2034-9 \$860.00

(3 pre-scored faucet holes)



MGCM2034-9PWT Polar White	114.0637.981
MGCM2034-9SG Stone Grey	114.0643.391
NEW MGCM2034-9SLG Slate Grey	114.0713.139
MGCM2034-9ON Onyx	114.0643.390
MGCM2034-9MBK Matte Black	114.0637.979
MGCM2034-9CHA Champagne	114.0637.971
MGCM2034-9ES Mocha	114.0643.389

Outside Sink Rim Dimensions: 19 11/16" FB x 33 7/8" LR
 Large Bowl Dimensions: 16 3/4" FB x 16 15/16" LR x 9 1/16" DP
 Small Bowl Dimensions: 14 3/8" FB x 13 5/16" LR x 8 5/8" DP
 Minimum Cabinet Size: 36"
 Corner Radius: 15mm
 Drain Hole Location: Rear
 Installation: Topmount / Drop In
 Shipping Weight: 50.0 lbs

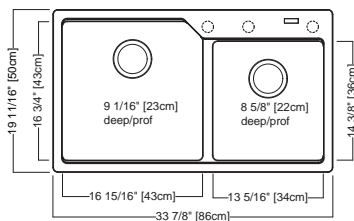

ACCESSORIES

- | | | | | |
|---|--------------------------------|--------------------------------|--------------------------------|----------------------------|
| 1 Strainer Basket
1135
2 Included | 2 Bottom Grid
BG450S | 3 Bottom Grid
BG440S | 7 Cutting Board
BB10 | 8 Colander
C417P |
|---|--------------------------------|--------------------------------|--------------------------------|----------------------------|

MGCM2031-9 \$835.00

(3 pre-scored faucet holes)



MGCM2031-9PWT Polar White	114.0637.980
MGCM2031-9SG Stone Grey	114.0643.387
NEW MGCM2031-9SLG Slate Grey	114.0713.136
MGCM2031-9ON Onyx	114.0643.386
MGCM2031-9MBK Matte Black	114.0637.978
MGCM2031-9CHA Champagne	114.0637.970
MGCM2031-9ES Mocha	114.0643.385

Outside Sink Rim Dimensions: 19 11/16" FB x 30 11/16" LR
 Large Bowl Dimensions: 16 3/4" FB x 14 1/8" LR x 8 5/8" DP
 Small Bowl Dimensions: 14 3/8" FB x 13" LR x 7 7/8" DP
 Minimum Cabinet Size: 33"
 Corner Radius: 15mm
 Drain Hole Location: Rear
 Installation: Topmount / Drop In
 Shipping Weight: 49.0 lbs

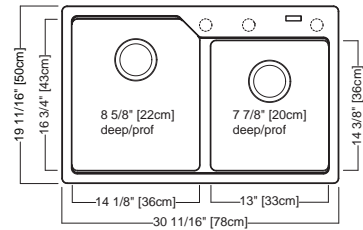

ACCESSORIES

- | | | | | |
|---|--------------------------------|--------------------------------|--------------------------------|----------------------------|
| 1 Strainer Basket
1135
2 Included | 4 Bottom Grid
BG430S | 3 Bottom Grid
BG440S | 7 Cutting Board
BB10 | 8 Colander
C417P |
|---|--------------------------------|--------------------------------|--------------------------------|----------------------------|

INCLUDED ACCESSORIES



- 1** Strainer Basket
1135
112.0040.566

OPTIONAL ACCESSORIES



- | | | | |
|--|--|--|--|
| 2 Bottom Grid
BG450S
112.0632.200
\$195.00 | 3 Bottom Grid
BG440S
112.0632.198
\$155.00 | 4 Bottom Grid
BG430S
112.0632.199
\$170.00 | 5 Bottom Grid
BG410S
112.0632.196
\$270.00 |
|--|--|--|--|



- | | | |
|--|--|--|
| 6 Bottom Grid
BG400S
112.0632.197
\$185.00 | 7 Cutting Board
BB10
112.0644.464
\$225.00 | 8 Colander
C417P
112.0538.950
\$100.00 |
|--|--|--|

PWT Polar White
 SG Stone Grey
 NEW SLG Slate Grey
 ON Onyx
 MBK Matte Black
 CHA Champagne
 ES Mocha
 Urban Granite
 Topmount / Drop In

Urban Granite
 Topmount / Drop In



Waste Disposers

CLEAN MACHINE

Kindred's waste disposers ensure durability and reliability at every step of clean-up.

Crafted with the Crown's standard of excellence, our waste disposers feature a sound-insulated shell for quiet performance. EZ Mount installation makes our disposers easy to install with just a few tools. Outfit your kitchen with Kindred's quality engineering and strength — right down to the drain.



KWD33C1-EZ \$235.00

134.0255.892



Horsepower: 1/3
 High-speed 1925 r.p.m. permanent magnet motor
 EZ mount installation system
 Stainless steel grinding components
 Includes factory installed power cord
 Safe for properly sized septic tanks
 For use with 110-120 volts/60hz current only
 Includes strainer stopper
 2 year warranty
 Antimicrobial treatment to inhibit odour
 Balanced grinding system to provide long service life & quiet operation
 Continuous feed
 Shipping Weight: 8.7 lbs

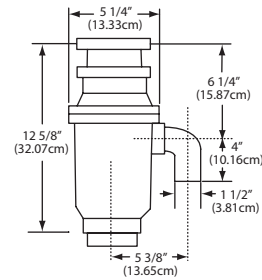

KWD75B1-EZ \$690.00

134.0275.324



Horsepower: 3/4
 High-speed 2700 r.p.m. permanent magnet motor
 EZ mount installation system
 Stainless steel grinding components
 Sound insulated shell
 Includes factory installed power cord
 Safe for properly sized septic tanks
 For use with 110-120 volts/60hz current only
 Includes strainer stopper
 8 year warranty
 Antimicrobial treatment to inhibit odour
 Balanced grinding system to provide long service life & quiet operation
 Batch feed
 Shipping Weight: 14 lbs

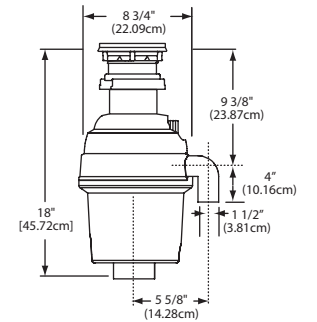

KWD50C1-EZ \$325.00

134.0255.890



Horsepower: 1/2
 High-speed 2600 r.p.m. permanent magnet motor
 EZ mount installation system
 Stainless steel grinding components
 Sound insulated shell
 Includes factory installed power cord
 Safe for properly sized septic tanks
 For use with 110-120 volts/60hz current only
 Includes strainer stopper
 5 year warranty
 Antimicrobial treatment to inhibit odour
 Balanced grinding system to provide long service life & quiet operation
 Continuous feed
 Shipping Weight: 10.6 lbs

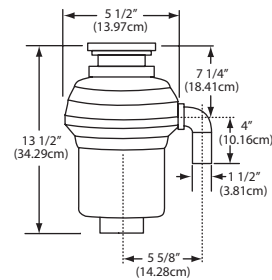

KWD125C1-EZ \$655.00

134.0255.899



Horsepower: 1 1/4
 High-speed 2800 r.p.m. permanent magnet motor
 EZ mount installation system
 Stainless steel grinding components
 Sound insulated shell
 Includes factory installed power cord
 Safe for properly sized septic tanks
 For use with 110-120 volts/60hz current only
 Includes strainer stopper
 10 year warranty
 Antimicrobial treatment to inhibit odour
 Balanced grinding system to provide long service life & quiet operation
 Continuous feed
 Shipping Weight: 15 lbs

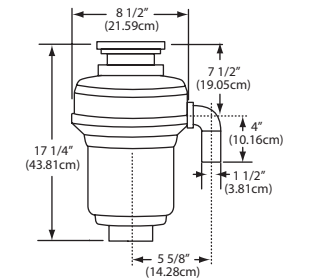

KWD50C2-EZ \$255.00

134.0262.596



Horsepower: 1/2
 High-speed 2600 r.p.m. permanent magnet motor
 EZ mount installation system
 Stainless steel grinding components
 Sound insulated shell
 Includes factory installed power cord
 Safe for properly sized septic tanks
 For use with 110-120 volts/60hz current only
 Includes strainer stopper
 2 year warranty
 Antimicrobial treatment to inhibit odour
 Balanced grinding system to provide long service life & quiet operation
 Continuous feed
 Shipping Weight: 10.6 lbs

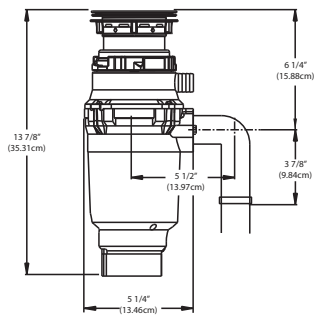

KWD125B1-EZ \$870.00

134.0315.656



Horsepower: 1 1/4
 High-speed 2800 r.p.m. permanent magnet motor
 EZ mount installation system
 Stainless steel grinding components
 Sound insulated shell
 Includes factory installed power cord
 Safe for properly sized septic tanks
 For use with 110-120 volts/60hz current only
 Includes strainer stopper
 10 year warranty
 Antimicrobial treatment to inhibit odour
 Balanced grinding system to provide long service life & quiet operation
 Batch feed
 Shipping Weight: 15 lbs

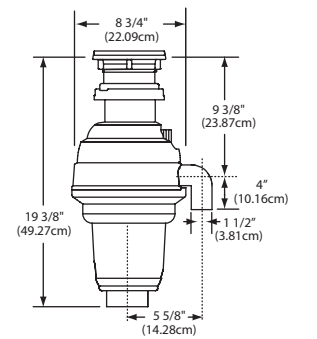

KWD75C1-EZ \$500.00

134.0255.898



Horsepower: 3/4
 High-speed 2700 r.p.m. permanent magnet motor
 EZ mount installation system
 Stainless steel grinding components
 Sound insulated shell
 Includes factory installed power cord
 Safe for properly sized septic tanks
 For use with 110-120 volts/60hz current only
 Includes strainer stopper
 8 year warranty
 Antimicrobial treatment to inhibit odour
 Balanced grinding system to provide long service life & quiet operation
 Continuous feed
 Shipping Weight: 12.0 lbs

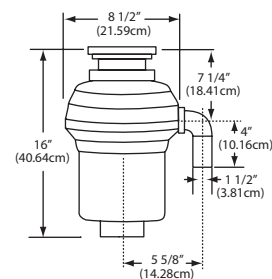

ACCESSORIES

AS200 \$235.00

112.0312.211



Includes separate chrome and satin nickel finished air switch control buttons
 For use with continuous feed waste disposers
 Can be used with waste disposers up to 1 H.P., 120 V
 Eliminates need for an electrical wall switch
 Installs into existing sink hole drilling, or countertop
 Air actuated on/off control
 Shipping Weight: 1.5 lbs

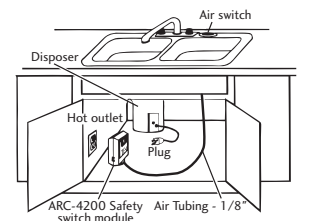



Sink Accessories

DELIGHTFUL DETAILS

No sink is complete without beautifully-designed and brilliantly-functional accessories.

Kindred offers an array of carefully crafted items sure to work seamlessly with our sinks and inspire creativity in the kitchen. Simplify meal prep and clean-up with accessories bearing the Kindred Crown — from colanders and drainers to cutting boards and grids. Whether you're chopping vegetables or washing dishes, the right accessories make the job a breeze.

Make your Kindred sink the high-functioning hub you require with accessories built to match beautifully — and to last.



112.0654.749 \$210.00



Bamboo Bridge Cutting Board
20 15/16" FB x 11" LR x 1 1/4" HIGH

MB517 \$210.00



Laminated Bamboo Cutting Board
17 1/2" FB x 11" LR x 1" HIGH

BB10 \$225.00



Laminated Bamboo Cutting Board
17 1/4" FB x 10 3/4" LR x 1" HIGH

C417P \$100.00



Grey ABS Colander
17.25" FB x 7" LR x 3 1/2" DEEP

CA1W \$20.00



White ABS Colander
13" FB x 9" LR x 4 1/2" DEEP

DBR10S \$200.00



Polished Stainless Steel
Drainer Basket
14 5/8" FB x 12" LR x 3" HIGH

RM55S \$245.00

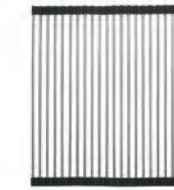

Polished Flexible
Stainless Steel Roller Mat
18" FB x 14 3/8" LR x 3/8" HIGH

BG10S \$185.00

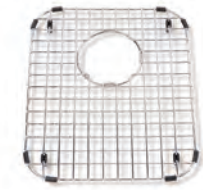

Polished Stainless Steel
Bottom Grid
14 1/4" FB x 11 7/8" LR x 1" HIGH

BG11S \$175.00



Polished Stainless Steel
Bottom Grid
14 1/4" FB x 15 1/4" LR x 1" HIGH

BG13S \$160.00

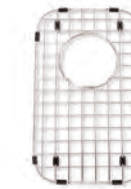

Polished Stainless Steel
Bottom Grid
14 1/4" FB x 8 1/4" LR x 1" HIGH

BG14S \$185.00

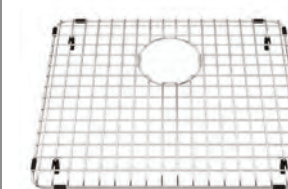

Polished Stainless Steel
Bottom Grid
15" FB x 18" LR x 1" HIGH

BG30S \$235.00

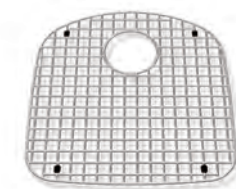

Polished Stainless Steel
Bottom Grid
16 7/8" FB x 16 3/16" LR x 1" HIGH

BG35S \$190.00

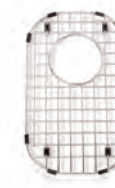

Polished Stainless Steel
Bottom Grid
14 1/4" FB x 8 1/2" LR x 1" HIGH

BG80S \$225.00

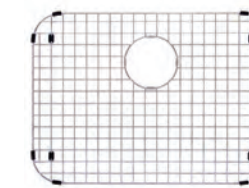

Polished Stainless Steel
Bottom Grid
14 3/4" FB x 20 3/8" LR x 1" HIGH

BG90S \$235.00

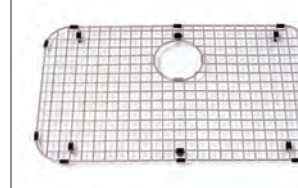

Polished Stainless Steel
Bottom Grid
14 5/8" FB x 25 1/4" LR x 1" HIGH

BG110S \$235.00

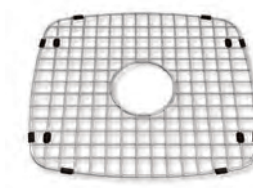

Polished Stainless Steel
Bottom Grid
13 7/8" FB x 15 7/8" LR x 1" HIGH

BG240S \$270.00

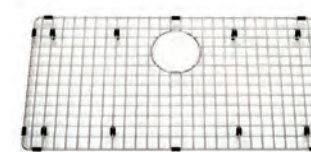

Polished Stainless Steel
Bottom Grid
14 1/4" FB x 27 1/4" LR x 1" HIGH

BG400S \$185.00

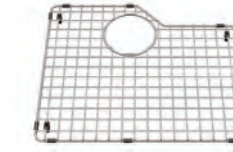

Polished Stainless Steel
Bottom Grid
15" FB x 18 1/4" LR x 1" HIGH

BG410S \$270.00

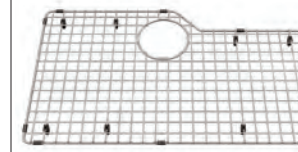

Polished Stainless Steel
Bottom Grid
15" FB x 26 1/2" LR x 1" HIGH

BG430S \$170.00

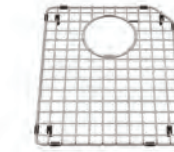

Polished Stainless Steel
Bottom Grid
15" FB x 12 1/4" LR x 1" HIGH

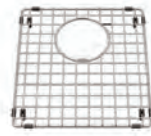

BG440S \$155.00

Polished Stainless Steel
Bottom Grid
13" FB x 11 3/4" LR x 1" HIGH

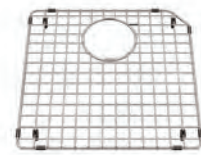
BG450S \$195.00

Polished Stainless Steel
Bottom Grid
15" FB x 15 1/4" LR x 1" HIGH

BG510S \$190.00

Polished Stainless Steel
Bottom Grid
15" FB x 8 3/4" LR x 1" HIGH

BG514S \$195.00

Polished Stainless Steel
Bottom Grid
15" FB x 12 1/2" LR x 1" HIGH

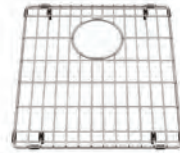
BG515S \$200.00

Polished Stainless Steel
Bottom Grid
15" FB x 13 1/2" LR x 1" HIGH

BG518S \$210.00

Polished Stainless Steel
Bottom Grid
15" FB x 16 1/2" LR x 1" HIGH

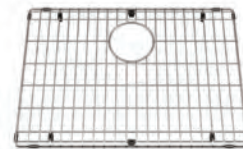
BG523S \$225.00

Polished Stainless Steel
Bottom Grid
15" FB x 21 1/2" LR x 1" HIGH

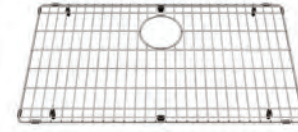
BG529S \$250.00

Polished Stainless Steel
Bottom Grid
15" FB x 27 1/2" LR x 1" HIGH

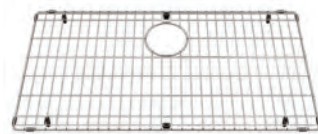
BG531S \$260.00

Polished Stainless Steel
Bottom Grid
15" FB x 29 1/2" LR x 1" HIGH

BG5310S \$260.00

Polished Stainless Steel
Bottom Grid
15" FB x 29 1/2" LR x 1" HIGH

BG1715C \$85.00

Polished Stainless Steel
Bottom Grid
15 1/2" FB x 13 1/2" LR x 1" HIGH

BG1715R \$85.00

Polished Stainless Steel
Bottom Grid
15 1/2" FB x 13 1/2" LR x 1" HIGH

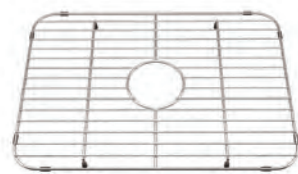
BG2317C \$100.00

Polished Stainless Steel
Bottom Grid
15 1/2" FB x 21 1/2" LR x 1" HIGH

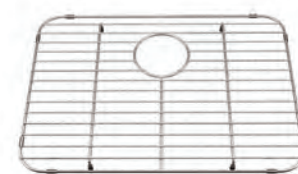
BG2317R \$100.00

Polished Stainless Steel
Bottom Grid
15 1/2" FB x 21 1/2" LR x 1" HIGH

BGA1217S \$140.00

Polished Stainless Steel
Bottom Grid
15" FB x 10 1/8" LR x 1" HIGH

BGA1517S \$185.00

Polished Stainless Steel
Bottom Grid
15" FB x 13" LR x 1" HIGH

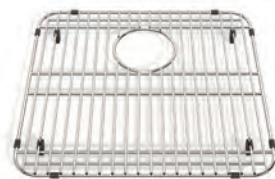
BGA1817S \$200.00

Polished Stainless Steel
Bottom Grid
15" FB x 16" LR x 1" HIGH

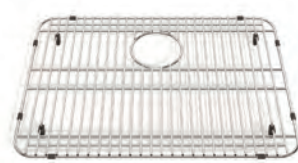
BGA2317S \$235.00

Polished Stainless Steel
Bottom Grid
15" FB x 21" LR x 1" HIGH

BGA3117S \$265.00

Polished Stainless Steel
Bottom Grid
15" FB x 29" LR x 1" HIGH

61621 \$45.00

Stainless Steel Cleaner

61411 \$25.00

Sink Maintenance Kit

4010856 \$25.00

Stainless Strainer Assembly

1135 \$40.00

Stainless Strainer Assembly

1135-CS \$40.00

Stainless Strainer Assembly
in Clam Shell Packaging

1140 \$45.00

Stainless Strainer Assembly

1135T \$15.00

Polypropylene Tailpiece
with Rubber Gasket

1130B \$25.00

Stainless Strainer Basket

1135B-CS \$20.00

Stainless Strainer Basket
in Clam Shell Packaging

100 \$35.00

1 1/2" Stainless Steel Waste
Fitting with Brass Tailpiece
& Rubber Stopper

1047 \$45.00

Integral Waste Assembly

31703 \$10.00

EZ Torque Sink Fastener

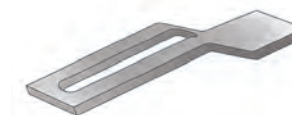
EL-CLIPS \$10.00

Undermount Installation Bracket

31548 \$10.00

8 Pc. Bolt & Claw Assembly
in Poly Bag

20102 \$10.00

Undermount Installation
Hardware Kit
Kindred undermount hardware kit
requires 3" additional cabinet space

Franke Home Solutions Warranty for Kindred Branded Product

Effective September 1, 2022

In the United States, Canada and Latin America, Franke warrants the Kindred products from manufacturing defects in material and workmanship when purchased from Franke or a Franke/Kindred Authorized Retailer pursuant to product-specific warranties detailed herein (each, a "Warranty" and collectively, the "Warranties"). The products must be properly installed, per company's installations instructions, in its original installation, and used in normal indoor residential kitchen applications. Any products or components which have been modified or altered, from its original intended condition will void the warranty. The Franke Warranties for Kindred branded products are limited to the original purchaser and are non-transferrable. These Warranties do not include products purchased from non-Authorized Retailers, products that are obsolete or discontinued, or products that were previous display models. All issues with installed products are considered warranty claims and not subject to the Return Policy. Franke reserves the right to inspect any Kindred product reported to be defective and the original installation prior to providing a replacement product and/or component. All decisions are final. In no situation shall the liability of Franke exceed the amount of the original purchase price.

The Warranties do not cover, and Franke shall not be liable for, any damage to products or components resulting from misuse or abuse, accidental damages, normal wear such as scuffs, scratches or finish reduction/fading; improper installation, abnormal usage, negligence, damage caused by improper maintenance or cleaning. Damage caused by impurities, corrosive chemicals or acts beyond Franke's control are not covered by any Warranty.

Kindred product replacements do not include transportation, shipping, diagnosis, labor, installation, removal, disposal for any products or liability for project delays. Product replacements are not guaranteed to be exact replacements. The owner of a product is liable for any transportation and re-installation costs related to any warranty for such product. If the original product is not available at the time of the warranty claim, at Franke's option, the product replacements will be of similar size, material, and value. Any products or components which have been modified or altered, from its original intended condition will void the warranty.

The Warranties do not allow recovery of incidental or consequential damages such as loss of use, delay, property damage or other consequential damage, and Franke accepts no liability for such damages. Each Warranty is limited to the conditions set forth herein and to the applicable warranty period specified herein and is exclusive. EXCEPT FOR THE WARRANTIES SET FORTH HEREIN, FRANKE MAKES NO WARRANTY WHATSOEVER WITH RESPECT TO THE PRODUCTS, INCLUDING, BUT NOT LIMITED TO, (1) ANY WARRANTY OF MERCHANTABILITY, (2) WARRANTY OF FITNESS FOR A PARTICULAR PURPOSE, (3) WARRANTY OF TITLE, OR (4) WARRANTY AGAINST INFRINGEMENT OF INTELLECTUAL PROPERTY RIGHTS OF A THIRD PARTY, WHETHER EXPRESS OR IMPLIED BY LAW, COURSE OF DEALING, COURSE OF PERFORMANCE, USAGE OF TRADE OR OTHERWISE. LEGAL DISCLAIMER PLEASE READ CAREFULLY. Franke Home Solutions North America, LLC/Franke Kindred Canada Limited provides the above information to you as a public service to our customers. By accessing and using this information, you agree to the following and to comply with all applicable laws. If you do not agree with these terms and conditions, do not use this information. While we try to keep the information current, changes may have occurred since its creation. Contact your Regional Manager or Customer Service to verify information regarding Franke Home Solutions North America, LLC/Franke Kindred Canada programs and their use by you.

Kindred Residential Stainless and Granite Sink Limited Lifetime Warranty:

Franke warrants that each Kindred sink will be free from manufacturing defects in material and workmanship for the lifetime of the sink when used in standard residential indoor applications. The warranty covers sinks installed in its original installation per Franke/Kindred installation instructions in residential applications using conventional or solid surface countertop.

Kindred Residential Disposal Limited Warranty:

Franke warrants that Kindred disposers are free from manufacturing defects in material and workmanship for the period ranging from two (2) years to ten (10) years as documented in the annual product catalogs and/or instructions included with the products.

Kindred Residential Faucet Limited Warranty:

Franke warrants that mechanical components (body, handle and spout) in all Kindred faucets purchased after January 1, 2003, will be free of manufacturing defects for ten (10) years. Franke shall not be liable for any damage caused by normal wear and tear to wearable parts of the faucet. The expected useful lifetime of wearable parts is; one (1) year: aerator, o-rings; five (5) years: cartridge, hose, ten (10) years: spray head. The wearable parts can be purchased as spare parts from Franke or their Kindred Authorized Retailers. Franke warrants the chrome finishes on Kindred faucets will be free of manufacturing defect for ten (10) years; and all other finishes on Kindred faucets will be free of manufacturing defects for five (5) years from the original date of purchase. Faucets purchased prior to 2003 are subject to the warranty in place at time of purchase.

Kindred Residential Soap Dispensers Limited Warranty:

Franke warrants that Kindred soap dispensers are free from manufacturing defects in material and workmanship for a period of one (1) year from the date of purchase. Such warranty does not cover damage caused by the use of aggressive soaps or chemicals.

Kindred Residential Accessories Limited Warranty:

Franke warrants that Kindred accessories, including, but not limited to bottom grids, shelves, waste kits, colanders, chopping boards are free from manufacturing defects in material and workmanship for a period of one (1) year from the dates of original purchase.

This warranty supersedes all other warranties, expressed or implied. No employee, field sales representatives, or distribution persons are authorized to give any warranties on behalf of Franke Home Solutions North America, LLC or Franke Kindred Canada Limited.

To make an installed product warranty claim please contact Franke at the provided contact information below. All warranty claims must include the following for processing:

1. Proof of purchase from Franke or Kindred Authorized Retailer
2. Original purchaser's name, address (included city, state, zip), email address and phone number
3. Kindred model number
4. Date of installation
5. Description of the defect
6. Photos of the defect

In the US and Mexico:

Franke Home Solutions North America, LLC

Attn: Warranty Department

800 Aviation Parkway

Smyrna, TN 37167

HS-Warranty.US@Franke.com

In Canada:

Franke Home Solutions

Attn: Warranty Department

1000 Franke Kindred Road

Midland, Ontario L4R 4K9

HS-Warranty.CA@Franke.com

Legal Entities: USA: Franke Home Solutions North America, LLC Canada: Franke Kindred Canada Limited

Terms & Conditions

GENERAL

- Products may only be sold and advertised within North America. Franke hereby expressly prohibits the dealer from soliciting or consummating sales outside of North America without prior written consent.
- Products shall only be sold in their original packaging. Relabeling, repackaging (including the separation of bundled products or the bundling of separate products), and other alterations are not permitted.
- Sale of Franke products on the Internet shall be prohibited unless resellers apply and are approved by Franke Home Solutions North America, LLC, and execute an Authorized Internet Reseller Agreement regulating the manner in which they sell online.

ORDERING

- Once an order has been acknowledged, changes (including additions or cancellations) will be accepted within 48 hours prior to shipping.
- Order acknowledgments are available via email or EDI. An email address must be provided to receive this benefit.

STANDARD PAYMENT TERMS

- Net 30 days.
- Franke reserves the right to charge interest and an administration fee on late payments.

PRICING

- Please refer to the electronically published price list (EPL). Orders will be priced with the prevailing price at the time the order is placed.
- Prices are subject to change without notice. Franke will attempt to provide reasonable lead time for pricing changes.

CLAIMS / CHARGE BACKS

- Damages/Shortages must be reported within ten (10) days of receipt of merchandise.
- Charge backs will not be accepted without an authorization number (RMA), provided by a National Sales Manager, Rep or Customer Service.

RETURNS

- No returns will be accepted without a return authorization number (RMA).
- Return authorization requests must be submitted through Rep/National Sales Manager.
- A 25% restocking fee will be charged for ALL returns of saleable product in original condition, not required
- Quality related issues can be returned with no restocking fee. Inspection required prior to shipping.
- No returns will be accepted more than 90 days from original invoice date, unless otherwise approved by NSM.
- No returns will be accepted on discontinued (DWO) or obsolete product.
- Franke reserves the right to decline / refuse returns with reason.

BACK ORDERS













































- Back order shipments will match terms in place by individual accounts.
- Back ordered product will be considered an active order unless customer requests cancellation.

PRODUCT REFERENCE GUIDE

MODEL	STRAINER BASKET	BOTTOM GRID	BAMBOO CUTTING BOARD	ROLLER MAT	COLANDER	PG	
 BSU1832-9	 1135 Included	 BG531S	 MB517	 RM55S	 C417P	14	
 BSU1832-90W	 1135 Included	 BG5310S	 MB517	 RM55S	 C417P	14	
 BSU1831-9	 1135 Included	 BG529S	 MB517	 RM55S	 C417P	14	
 BSU1825-9	 1135 Included	 BG523S	 MB517	 RM55S	 C417P	15	
 BSU1820-9	 1135 Included	 BG518S	 MB517	 RM55S	 C417P	15	
 BSU1816-9	 1135 Included	 BG514S	 MB517	 RM55S	 C417P	16	
 BSU1812-8	 1135 Included	 BG510S	 MB517	 RM55S	 C417P	16	
 BCU1836R-9	 1135 2 Included	 BG523S	 BG510S	 MB517	 RM55S	 C417P	16
 BCU1835R-9	 1135 2 Included	 BG518S	 BG514S	 MB517	 RM55S	 C417P	17
 BCU1831R-9	 1135 2 Included	 BG518S	 BG510S	 MB517	 RM55S	 C417P	17
 BCU1827R-9	 1135 2 Included	 BG514S	 BG510S	 MB517	 RM55S	 C417P	18
 BDU1831-9	 1135 2 Included	 BG514S	 MB517	 RM55S	 C417P	18	
 BTU1841-9	 1135 3 Included	 BG514S	 BG510S	 MB517	 RM55S	 C417P	18



























MODEL	STRAINER BASKET	BOTTOM GRID	BAMBOO CUTTING BOARD	ROLLER MAT	COLANDER	PG	
BSL2233-9-4 BSL2233-9-3 BSL2233-9-1	 1135 Included	 BG531S	 MB517	 RM55S	 C417P	22	
BSL2233-9-4OW BSL2233-9-3OW BSL2233-9-1OW	 1135 Included	 BG531OS	 MB517	 RM55S	 C417P	22	
BSL2131-9-4 BSL2131-9-3 BSL2131-9-1	 1135 Included	 BG529S	 MB517	 RM55S	 C417P	22	
BSL2225-9-4 BSL2225-9-3 BSL2225-9-1	 1135 Included	 BG523S	 MB517	 RM55S	 C417P	23	
BSL2125-9-4 BSL2125-9-3 BSL2125-9-1	 1135 Included	 BG523S	 MB517	 RM55S	 C417P	23	
BSL2120-9-4 BSL2120-9-3 BSL2120-9-1	 1135 Included	 BG518S	 MB517	 RM55S	 C417P	24	
BSL2116-9-3 BSL2116-9-1	 1135 Included	 BG514S	 MB517	 RM55S	 C417P	24	
BCL2131R-9-4 BCL2131R-9-3 BCL2131R-9-1	 1135 2 Included	 BG518S	 BG510S	 MB517	 RM55S	 C417P	24
BCL2127R-9-4 BCL2127R-9-3 BCL2127R-9-1	 1135 2 Included	 BG514S	 BG510S	 MB517	 RM55S	 C417P	25
BDL2233-9-4 BDL2233-9-3 BDL2233-9-1	 1135 2 Included	 BG515S	 MB517	 RM55S	 C417P	25	
BDL2131-9-4 BDL2131-9-3 BDL2131-9-1	 1135 2 Included	 BG514S	 MB517	 RM55S	 C417P	26	

Brookmore Topmount / Drop In

MODEL	STRAINER BASKET	BOTTOM GRID	BAMBOO CUTTING BOARD	ROLLER MAT OR DRAINER BASKET	COLANDER	PG
BSL2225-ADA-1	 1135 Included	 BG523S	 MB517	 RM55S	 C417P	29
BSL2233-ADA-1	 1135 Included	 BG531S	 MB517	 RM55S	 C417P	29
QSU1933-8	 1135 Included	 BGA3117S	 112.0654.749	 DBR10S		34
QSU1831-8	 1135 Included	 BG240S	 112.0654.749	 DBR10S	 RM55S	34
QSU1925-8	 1135 Included	 BGA2317S	 112.0654.749	 DBR10S		34
QSU1922-8	 1135 Included	 BG14S	 112.0654.749	 DBR10S		35
QSU1917-8	 1135 Included	 BGA1517S	 112.0654.749	 DBR10S		35
QSU1820-8	 1135 Included	 BG11S	 112.0654.749	 DBR10S	 RM55S	36
QSU1616-6	 1135 Included		 112.0654.749	 RM55S		36
QSU1816-8	 1135 Included	 BG10S	 112.0654.749	 DBR10S	 RM55S	36

Brookmore ADA

Steel Queen Undermount

MODEL	STRAINER BASKET	BOTTOM GRID	BAMBOO CUTTING BOARD	COLANDER	ROLLER MAT	DRAINER BASKET	PG
 QSU1113-6	 1135 Included		 112.0654.749				37
 QCUA1933R-8	 1135 2 Included	 BGA1217S	 112.0654.749			 DBR10S	37
 QCUA1831R-8	 1135 2 Included	 BG11S	 112.0654.749	 CA1W Included	 RM55S	 DBR10S	38
 QCUA1827R-8	 1135 2 Included	 BG10S	 112.0654.749	 CA1W Included	 RM55S	 DBR10S	38
 QDUA1933-8	 1135 2 Included	 BGA1517S	 112.0654.749			 DBR10S	38
 QDUA1831-8	 1135 2 Included	 BG10S	 112.0654.749		 RM55S	 DBR10S	39























Steel Queen Undermount

MODEL	STRAINER BASKET	BOTTOM GRID	BAMBOO CUTTING BOARD	ROLLER MAT	DRAINER BASKET	PG
 QSLA2233-8-4 QSLA2233-8-3 QSLA2233-8-1	 1135 Included	 BGA3117S		 RM55S	 DBR10S	42
 QSLA2031-8-4 QSLA2031-8-3 QSLA2031-8-1	 1135 Included	 BG240S		 RM55S	 DBR10S	42
 QSLA2225-8-4 QSLA2225-8-3 QSLA2225-8-1	 1135 Included	 BGA2317S		 RM55S	 DBR10S	42
 QSLA2217-8-3 QSLA2217-8-1	 1135 Included	 BGA1517S		 RM55S	 DBR10S	43
 QSL2020-8-3 QSL2020-8-1	 1135 Included	 BG11S		 RM55S	 DBR10S	43
 QSA1820-8	 1135 Included	 BG11S	 112.0654.749	 RM55S	 DBR10S	44
 QSA1816-8	 1135 Included	 BG10S	 112.0654.749	 RM55S	 DBR10S	44
 QSL2020-7-3 QSL2020-7-1	 1135 Included	 BG11S		 RM55S	 DBR10S	44





Steel Queen Topmount / Drop In

MODEL	STRAINER BASKET	BOTTOM GRID	BAMBOO CUTTING BOARD	COLANDER	ROLLER MAT	DRAINER BASKET	PG
QCLA2031R-8-3 QCLA2031R-8-1 QCLA2031L-8-3 QCLA2031L-8-1	 1135 2 Included	 BG115		 CA1W Included	 RM55S	 DBR10S	45
QDLA2233-8-4 QDLA2233-8-3 QDLA2233-8-1	 1135 2 Included	 BGA1517S			 RM55S	 DBR10S	45
QCLA2027R-8-3 QCLA2027R-8-1 QCLA2027L-8-3 QCLA2027L-8-1	 1135 2 Included	 BG10S		 CA1W Included	 RM55S	 DBR10S	46
QDL2031-8-4 QDL2031-8-3 QDL2031-8-1	 1135 2 Included	 BG10S			 RM55S	 DBR10S	46
QCMA1826-7-3 QCMA1826-7-1	 1135 2 Included	 BG10S	 112.0654.749		 RM55S	 DBR10S	46
QD1831-8	 1135 2 Included	 BG10S	 112.0654.749		 RM55S	 DBR10S	47
QDL2031-7-4 QDL2031-7-3 QDL2031-7-1	 1135 2 Included	 BG10S			 RM55S	 DBR10S	47





























Steel Queen Topmount / Drop In

MODEL	STRAINER BASKET	BOTTOM GRID	DRAINER BASKET	ROLLER MAT	PG
QSLF2020-12-3 QSLF2020-12-1	 1135 Included		 DBR10S	 RM55S	50
QSLF2020-10-3 QSLF2020-10-1	 1135 Included		 DBR10S	 RM55S	50
QSL2225-12-3 QSL2225-12-1	 1135 Included				50
QSLA2225-10-4 QSLA2225-10-3 QSLA2225-10-1	 1135 Included	 BGA2317S		 RM55S	51
QSL2020-10-3 QSL2020-10-1	 1135 Included	 BG110S		 RM55S	51
QSU1820-10	 1135 Included	 BG110S		 RM55S	52
QS1820-10	 1135 Included	 BG110S		 RM55S	52
RSL2020-10-3 RSL2020-10-1	 1135 Included	 BG110S		 RM55S	52













Steel Queen Utility - Laundry

MODEL	STRAINER BASKET	PG
QSL1719-8-3 QSL1719-8-2 QSL1719-8-1	 1135 Included	54
QSL1515-6-2 QSL1515-6-1	 1135 Included	54
QS1315-6	 1135 Included	54
QSL1313-6-2 QSL1313-6-1	 1135 Included	55
QS1113-6	 1135 Included	55































Steel Queen Utility - Hospitality













































MODEL	STRAINER BASKET	BOTTOM GRID	BAMBOO CUTTING BOARD	ROLLER MAT	PG
 CSLA1515-6-2CBN					62
 CSLA2522-8-4CB CSLA2522-8-3CB CSLA2522-8-1CB	 4010856 Included	 BG2317R			62
 CSLA2522-7-4 CSLA2522-7-3 CSLA2522-7-1	 4010856 Included	 BG2317C			62
 CSLA2522-6-4 CSLA2522-6-3 CSLA2522-6-1	 4010856 Included	 BG2317C			63
 FCDLA3322-8-4CB FCDLA3322-8-3CB FCDLA3322-8-1CB	 4010856 2 Included	 BG1715R	 112.0654.749		63
 CDLA3322-8-4CB CDLA3322-8-3CB CDLA3322-8-1CB	 4010856 2 Included	 BG1715R	 112.0654.749		64
 CDLA3322-7-4 CDLA3322-7-3 CDLA3322-7-1	 4010856 2 Included	 BG1715C	 112.0654.749		64
 CDLA3322-6-4 CDLA3322-6-3 CDLA3322-6-1	 4010856 2 Included	 BG1715C	 112.0654.749		64
 RDLA3319-6-4CB	 4010856 2 Included		 112.0654.749		65

Creemore Topmount / Drop In

MODEL	STRAINER BASKET	BOTTOM GRID	BAMBOO CUTTING BOARD OR ROLLER MAT	DRAINER BASKET	PG
 NS1930U-9	 1135 Included	 BG90S	 112.0654.749	 DBR10S	70
 NS1925U-9	 1135 Included	 BG80S	 112.0654.749	 DBR10S	70
 NS1820UA-9	 1135 Included	 BG11S	 112.0654.749	 RM55S	70
 RSU1820-7	 1135 Included	 BG11S	 112.0654.749	 RM55S	71
 NS1813U-7	 1135 Included	 BG35S			71
 ND1831UA-9	 1135 2 Included	 BG10S	 112.0654.749	 RM55S	 DBR10S
 NDC1827RU-9	 1135 2 Included	 BG10S	 BG13S	 112.0654.749	 RM55S
 RDU1831-7	 1135 2 Included	 BG10S	 112.0654.749	 RM55S	 DBR10S

Reginox Undermount

	MODEL	STRAINER BASKET	BOTTOM GRID	BAMBOO CUTTING BOARD OR ROLLER MAT	DRAINER BASKET	PG
Reginox Topmount / Drop In	 RSL2020-3 RSL2020-1	 1135 Included	 BG110S			76
	 RSL5251-3 RSL5251-1	 1140 Included	 BG110S			76
	 RCL2027R-3 RCL2027R-1	 1135 2 Included	 BG10S	 RM55S	 DBR10S	76
	 RDL5279-4 RDL5279-3 RDL5279-1	 1135 2 Included	 BG10S	 RM55S	 DBR10S	77
	 RDL2031-3 RDL2031-1	 1135 2 Included	 BG10S	 RM55S	 DBR10S	77
Reginox ADA	 RSU1829-55	 1135 1 Included		 112.0654.749		80
	 RSU1925-55	 1135 1 Included		 112.0654.749		80
	 RSLA2522-55-4 RSLA2522-55-3 RSLA3322-55-1	 1135 1 Included				80
	 RDLA3322-55-4 RDLA3322-55-3 RDLA3322-55-1	 1135 2 Included				81

MODEL	STRAINER BASKET	BOTTOM GRID	BAMBOO CUTTING BOARD	COLANDER	PG	
 MGS2031U-9	 1135 Included	 BG410S	 BB10	 C417P	86	
 MGS2022U-9	 1135 Included	 BG400S	 BB10	 C417P	86	
 MGC2034U-9	 1135 2 Included	 BG450S	 BG440S	 BB10	 C417P	86
 MGC2031U-9	 1135 2 Included	 BG430S	 BG440S	 BB10	 C417P	87
 MGSM2031-9	 1135 Included	 BG410S	 BB10	 C417P	90	
 MGSM2022-9	 1135 Included	 BG400S	 BB10	 C417P	90	
 MGCM2034-9	 1135 2 Included	 BG450S	 BG440S	 BB10	 C417P	90
 MGCM2031-9	 1135 2 Included	 BG430S	 BG440S	 BB10	 C417P	91



MINIMUM CABINET SIZE

15"



BSL2116-9-3
Page 24



BSL2116-9-1
Page 24



BSL2120-9-4
BSL2120-9-3
BSL2120-9-1
Page 24

18"



BSL2116-9-3
BSL2116-9-1
Page 24



BSL2116-9-1
Page 24



BSL2120-9-4
BSL2120-9-3
BSL2120-9-1
Page 24



BSL2120-9-3
Page 24



BSL2120-9-1
Page 24



BSL2120-9-1
Page 24

21"



BSL2120-9-4
BSL2120-9-3
BSL2120-9-1
Page 24



BSL2120-9-3
Page 24



BSL2120-9-1
Page 24



BSL2120-9-1
Page 24



BSL2120-9-1
Page 24



BSL2120-9-1
Page 24

24"



BSL2120-9-4
BSL2120-9-3
BSL2120-9-1
Page 24



BSL2120-9-3
Page 24



BSL2120-9-1
Page 24



BSL2120-9-1
Page 24



BSL2120-9-1
Page 24



BSL2120-9-1
Page 24

MINIMUM CABINET SIZE

MINIMUM CABINET SIZE

27"



BCU1827R-9
Page 18



BSL2125-9-4
BSL2125-9-3
BSL2125-9-1
Page 23



BSL2225-9-4
BSL2225-9-3
BSL2225-9-1
Page 23



BSL2225-ADA-1
Page 29



BSU1825-9
Page 15



CSLA2522-6-4
CSLA2522-6-3
CSLA2522-6-1
Page 63



CSLA2522-7-4
CSLA2522-7-3
CSLA2522-7-1
Page 62



CSLA2522-8-4CB
CSLA2522-8-3CB
CSLA2522-8-1CB
Page 62



NS1925U-9
Page 70



QSL2225-12-3
QSL2225-12-1
Page 50



QSLA2225-10-4
QSLA2225-10-3
QSLA2225-10-1
Page 51



QSLA2225-8-4
QSLA2225-8-3
QSLA2225-10-1
Page 42



QSUA1925-8
Page 34



RSLA2522-55-4
RSLA2522-55-3
RSLA2522-55-1
Page 80



RSU1925-55
Page 80

30"



BCL2127R-9-4
BCL2127R-9-3
BCL2127R-9-1
Page 25



NDC1827RU-9
Page 72



QCLA2027R-8-3
QCLA2027R-8-1
QCLA2027L-8-3
QCLA2027L-8-1
Page 46



QCMA1826-7-3
QCMA1826-7-1
Page 46



QCUA1827R-8
QCUA1827L-8
Page 38



RCL2027R-3
RCL2027R-1
Page 76

33"



BCL2131R-9-4
BCL2131R-9-3
BCL2131R-9-1
Page 24



BCU1831R-9
Page 17



BDL2131-9-4
BDL2131-9-3
BDL2131-9-1
Page 26



BDU1831-9
Page 18



BSL2131-9-4
BSL2131-9-3
BSL2131-9-1
Page 22



BSU1831-9
Page 14



BSU1832-9
Page 14



BSU1832-90W
Page 14



MGC2031U-9
Page 87



MGCM2031-9
Page 91



MGS2031U-9
Page 86



MGS2031-9
Page 90



ND1831UA-9
Page 72



NS1930U-9
Page 70



QCLA2031R-8-3
QCLA2031R-8-1
QCLA2031L-8-3
QCLA2031L-8-1
Page 45



QCUA1831R-8
QCUA1831L-8
Page 38



QCUA1933R-8
Page 37



QD1831-8
Page 47

33"



QDL2031-8-4
QDL2031-8-3
QDL2031-8-1
Page 46



QDL2031-7-4
QDL2031-7-3
QDL2031-7-1
Page 47



QDUA1831-8
Page 39



QDUA1933-8
Page 38



QSLA2031-8-4
QSLA2031-8-3
QSLA2031-8-1
Page 42



QSUA1831-8
Page 34



QSUA1933-8
Page 34



RDL2031-3
RDL2031-1
Page 77



RDL5279-4
RDL5279-3
RDL5279-1
Page 77



RDU1831-7
Page 72



RSU1829-55
Page 80

36"



BCU1835R-9
Page 17



BDL2233-9-4
BDL2233-9-3
BDL2233-9-1
Page 25



BSL2233-9-4
BSL2233-9-3
BSL2233-9-1
Page 22



BSL2233-ADA-1
Page 29



BSL2233-9-40W
BSL2233-9-30W
BSL2233-9-10W
Page 22



CDLA3322-6-4
CDLA3322-6-3
CDLA3322-6-1
Page 64



CDLA3322-7-4
CDLA3322-7-3
CDLA3322-7-1
Page 64



CDLA3322-8-4CB
CDLA3322-8-3CB
CDLA3322-8-1CB
Page 64



FCDLA3322-8-4CB
FCDLA3322-8-3CB
FCDLA3322-8-1CB
Page 63



MGC2034U-9
Page 86



MGCM2034-9
Page 90



QDLA2233-8-4
QDLA2233-8-3
QDLA2233-8-1
Page 45



QSLA2233-8-4
QSLA2233-8-3
QSLA2233-8-1
Page 42



RDLA3319-6-4CB
Page 65



RDLA3322-55-4
RDLA3322-55-3
RDLA3322-55-1
Page 81



BCU1836R-9
Page 16

42"



BTU1841-9
Page 18

SINKS

BCL2127R-9-1 / 101.0636.942	\$990.00	25	CDLA3322-7-1 / 101.0637.037	\$345.00	64	MGSM2022U-9PWT / 125.0637.132	\$730.00	86	QDLA2233-8-1 / 101.0169.264	\$1,015.00	45	QSUAA1933-8 / 122.0170.398	\$760.00	34	61621 / 112.0061.299	\$45.00	99
BCL2127R-9-3 / 101.0636.944	\$990.00	25	CDLA3322-7-3 / 101.0637.038	\$345.00	64	MGSM2022U-9SG / 125.0641.541	\$730.00	86	QDLA2233-8-3 / 101.0169.265	\$1,015.00	45	RCL2027R-1 / 101.0045.283	\$490.00	76	AS200 / 112.0312.211	\$235.00	95
BCL2127R-9-4 / 101.0636.946	\$990.00	25	CDLA3322-7-4 / 101.0637.039	\$345.00	64	MGSM2022U-9SLG / 125.0713.140	\$730.00	86	QDLA2233-8-4 / 101.0169.266	\$1,015.00	45	RCL2027R-3 / 101.0045.284	\$490.00	76	BB10 / 112.0644.464	\$225.00	97
BCL2131R-9-1 / 101.0636.948	\$1,035.00	24	CDLA3322-8-1CB / 101.0637.040	\$400.00	64	MGSM2031U-9CHA / 125.0637.125	\$835.00	86	QDUA1831-8 / 122.0187.705	\$745.00	39	RDL2031-1 / 101.0045.294	\$465.00	77	BG10S / 112.0044.785	\$185.00	97
BCL2131R-9-3 / 101.0636.950	\$1,035.00	24	CDLA3322-8-3CB / 101.0637.041	\$400.00	64	MGSM2031U-9ES / 125.0641.543	\$835.00	86	QDUA1933-8 / 122.0170.394	\$835.00	38	RDL2031-3 / 101.0045.295	\$465.00	77	BG11S / 112.0044.786	\$175.00	97
BCL2131R-9-4 / 101.0636.952	\$1,035.00	24	CDLA3322-8-4CB / 101.0637.042	\$400.00	64	MGSM2031U-9MBK / 125.0637.129	\$835.00	86	QSL1113-6 / 113.0045.193	\$340.00	55	RDL5279-1 / 101.0045.297	\$480.00	77	BG13S / 112.0367.605	\$160.00	97
BCU1827R-9 / 122.0637.626	\$910.00	18	CSLA1515-6-2CBN / 101.0651.328	\$290.00	62	MGSM2031U-9ON / 125.0641.544	\$835.00	86	QSL1315-6 / 113.0045.194	\$380.00	55	RDL5279-3 / 101.0045.298	\$480.00	77	BG14S / 112.0486.240	\$185.00	97
BCU1831R-9 / 122.0637.628	\$940.00	17	CSLA2522-6-1 / 101.0637.043	\$250.00	63	MGSM2031U-9PWT / 125.0637.135	\$835.00	86	QSL1820-10 / 101.0557.587	\$760.00	52	RDL5279-4 / 101.0045.299	\$480.00	77	BG240S / 112.0204.314	\$270.00	97
BCU1835R-9 / 122.0637.630	\$965.00	17	CSLA2522-6-3 / 101.0637.044	\$250.00	63	MGSM2031U-9SG / 125.0641.545	\$835.00	86	QSA1816-8 / 101.0202.339	\$435.00	44	RDLA3319-6-4CB / 101.0689.157	\$310.00	65	BG30S / 112.0055.435	\$235.00	97
BCU1836R-9 / 122.0637.632	\$990.00	16	CSLA2522-6-4 / 101.0637.045	\$250.00	63	MGSM2031U-9SLG / 125.0713.142	\$835.00	86	QSA1820-8 / 101.0202.331	\$445.00	44	RDLA3322-55-1 / 101.0634.002	\$695.00	81	BG35S / 112.0044.796	\$190.00	97
BDL2131-9-1 / 101.0636.961	\$805.00	26	CSLA2522-7-1 / 101.0637.046	\$260.00	62	MGSM2022-9CHA / 114.0637.968	\$690.00	90	QSL1313-6-1 / 113.0045.207	\$340.00	55	RDLA3322-55-3 / 101.0643.195	\$695.00	81	BG80S / 112.0044.793	\$225.00	97
BDL2131-9-3 / 101.0636.963	\$805.00	26	CSLA2522-7-3 / 101.0637.047	\$260.00	62	MGSM2022-9ES / 114.0643.393	\$690.00	90	QSL1313-6-2 / 113.0045.208	\$340.00	55	RDLA3322-55-4 / 101.0643.196	\$695.00	81	BG90S / 112.0044.794	\$235.00	97
BDL2131-9-4 / 101.0636.965	\$805.00	26	CSLA2522-7-4 / 101.0637.048	\$260.00	62	MGSM2022-9MBK / 114.0637.976	\$690.00	90	QSL1515-6-1 / 113.0045.210	\$405.00	54	RDU1831-7 / 122.0391.891	\$370.00	72	BG110S / 112.0040.526	\$235.00	97
BDL2233-9-1 / 101.0636.967	\$940.00	25	CSLA2522-8-1CB / 101.0637.049	\$290.00	62	MGSM2022-9ON / 114.0643.394	\$690.00	90	QSL1515-6-2 / 113.0045.211	\$405.00	54	RSL2020-10-1 / 101.0691.856	\$665.00	52	BG400S / 112.0632.197	\$185.00	97
BDL2233-9-3 / 101.0636.968	\$940.00	25	CSLA2522-8-3CB / 101.0637.050	\$290.00	62	MGSM2022-9PWT / 114.0643.395	\$690.00	90	QSL1719-8-1 / 101.0045.213	\$480.00	54	RSL2020-10-3 / 101.0255.448	\$665.00	52	BG410S / 112.0632.196	\$270.00	97
BDL2233-9-4 / 101.0636.969	\$940.00	25	CSLA2522-8-4CB / 101.0637.051	\$290.00	62	MGSM2022-9SG / 114.0643.396	\$690.00	90	QSL1719-8-2 / 101.0045.214	\$480.00	54	RSL2020-1 / 101.0045.301	\$270.00	76	BG430S / 112.0632.199	\$170.00	97
BDU1831-9 / 122.0637.633	\$840.00	18	FCDLA3322-8-1CB / 101.0637.052	\$445.00	63	MGSM2022-9SLG / 114.0713.132	\$690.00	90	QSL1719-8-3 / 101.0045.215	\$480.00	54	RSL2020-3 / 101.0045.302	\$270.00	76	BG440S / 112.0632.198	\$155.00	98
BSL2116-9-1 / 101.0636.972	\$560.00	24	FCDLA3322-8-3CB / 101.0637.053	\$445.00	63	MGSM2031-9CHA / 114.0637.969	\$795.00	90	QSL2020-10-1 / 113.0045.221	\$785.00	51	RSL5251-1 / 101.0045.304	\$280.00	76	BG450S / 112.0632.200	\$195.00	98
BSL2116-9-3 / 101.0636.974	\$560.00	24	FCDLA3322-8-4CB / 101.0652.631	\$445.00	63	MGSM2031-9ES / 114.0643.398	\$795.00	90	QSL2020-10-3 / 113.0045.222	\$785.00	51	RSL5251-3 / 101.0045.305	\$280.00	76	BG510S / 112.0624.292	\$190.00	98
BSL2120-9-1 / 101.0636.976	\$590.00	24	MGC2031U-9CHA / 125.0637.126	\$870.00	87	MGSM2031-9MBK / 114.0637.977	\$795.00	90	QSL2020-7-1 / 101.0045.225	\$350.00	44	RSLA2522-55-1 / 101.0643.197	\$580.00	80	BG514S / 112.0624.290	\$195.00	98
BSL2120-9-3 / 101.0636.978	\$590.00	24	MGC2031U-9SG / 125.0641.533	\$870.00	87	MGSM2031-9ON / 114.0643.399	\$795.00	90	QSL2020-7-3 / 101.0045.226	\$350.00	44	RSLA2522-55-3 / 101.0643.198	\$580.00	80	BG515S / 112.0624.288	\$200.00	98
BSL2120-9-4 / 101.0636.980	\$590.00	24	MGC2031U-9MBK / 125.0637.130	\$870.00	87	MGSM2031-9PWT / 114.0637.983	\$795.00	90	QSL2020-8-1 / 101.0045.229	\$455.00	43	RSLA2522-55-4 / 101.0643.199	\$580.00	80	BG518S / 112.0624.287	\$210.00	98
BSL2125-9-1 / 101.0636.982	\$700.00	23	MGC2031U-9ON / 125.0641.532	\$870.00	87	MGSM2031-9SG / 114.0643.400	\$795.00	90	QSL2020-8-3 / 101.0045.230	\$455.00	43	RSU1820-7 / 122.0483.903	\$300.00	71	BG523S / 112.0624.286	\$225.00	98
BSL2125-9-3 / 101.0636.984	\$700.00	23	MGC2031U-9PWT / 125.0637.133	\$870.00	87	MGSM2031-9SLG / 114.0713.134	\$795.00	90	QSL2225-12-1 / 101.0689.150	\$1,245.00	50	RSU1829-55 / 122.0641.407	\$580.00	80	BG529S / 112.0624.283	\$250.00	98
BSL2125-9-4 / 101.0636.986	\$700.00	23	MGC2031U-9SG / 125.0641.533	\$870.00	87	ND1831UA-9 / 122.0523.305	\$610.00	72	QSL2225-12-3 / \$1,245.00		50	RSU1925-55 / 122.0641.408	\$490.00	80	BG531S / 112.0624.284	\$260.00	98
BSL2131-9-1 / 101.0636.988	\$750.00	22	MGC2031U-9SLG / 125.0713.144	\$870.00	87	NDC1827RU-9	\$520.00	72	QSLA2031-8-1 / 101.0202.185	\$805.00	42				BG5310S / 112.0624.285	\$260.00	98
BSL2131-9-3 / 101.0636.990	\$750.00	22	MGC2034U-9CHA / 125.0637.127	\$900.00	86	NS1813U-7 / 122.0264.714	\$260.00	71	QSLA2031-8-3 / 101.0202.187	\$805.00	42				BG1715C / 112.0611.546	\$85.00	98
BSL2131-9-4 / 101.0636.992	\$750.00	22	MGC2034U-9ES / 125.0641.535	\$900.00	86	NS1820UA-9 / 122.0523.289	\$395.00	70	QSLA2031-8-4 / 101.0202.189	\$805.00	42				BG1715R / 112.0611.548	\$85.00	98
BSL2225-ADA-1 / 101.0689.852	\$730.00	29	MGC2034U-9ES / 125.0641.535	\$900.00	86	NS1925U-9 / 122.0264.715	\$415.00	70	QSLA2217-8-1 / 101.0169.281	\$560.00	43				BG2317C / 112.0611.545	\$100.00	98
BSL2225-9-1 / 101.0636.994	\$730.00	23	MGC2034U-9MBK / 125.0637.131	\$900.00	86	NS1930U-9 / 122.0264.716	\$510.00	70	QSLA2217-8-3 / 101.0169.282	\$560.00	43				BG2317R / 112.0611.550	\$100.00	98
BSL2225-9-3 / 101.0636.996	\$730.00	23	MGC2034U-9ON / 125.0641.536	\$900.00	86	QCLA2027L-8-1 / 101.0202.160	\$1,000.00	46	QSLA2225-10-1 / 101.0522.738	\$1,070.00	51				BGA1217S / 112.0174.874	\$140.00	98
BSL2225-9-4 / 101.0636.998	\$730.00	23	MGC2034U-9PWT / 125.0637.134	\$900.00	86	QCLA2027L-8-3 / 101.0202.172	\$1,000.00	46	QSLA2225-10-3 / 101.0522.739	\$1,070.00	51				BGA1517S / 112.0174.872	\$185.00	98
BSL2233-ADA-1 / 101.0689.855	\$780.00	29	MGC2034U-9SG / 125.0641.537	\$900.00	86	QCLA2027R-8-1 / 101.0202.029	\$1,000.00	46	QSLA2225-10-4 / 101.0689.151	\$1,070.00	51				BGA1817S / 112.0174.876	\$200.00	98
BSL2233-9-1 / 101.0637.001	\$780.00	22	MGC2034U-9SLG / 125.0713.146	\$900.00	86	QCLA2027R-8-3 / 101.0202.031	\$1,000.00	46	QSLA2225-8-1 / 101.0169.278	\$730.00	42				BGA2317S / 112.0174.875	\$235.00	98
BSL2233-9-3 / 101.0637.003	\$780.00	22	MGCM2031-9CHA / 114.0637.970	\$835.00	91	QCLA2031L-8-1 / 101.0201.842	\$1,040.00	45	QSLA2225-8-3 / 101.0169.279	\$730.00	42				BGA3117S / 112.0174.878	\$265.00	98
BSL2233-9-4 / 101.0637.005	\$780.00	22	MGCM2031-9ES / 114.0643.385	\$835.00	91	QCLA2031L-8-3 / 101.0201.844	\$1,040.00	45	QSLA2225-8-4 / 101.0169.280	\$730.00	42				CA1W / 112.0202.209	\$20.00	97
BSL2233-9-10W / 101.0637.002	\$780.00	22	MGCM2031-9MBK / 114.0637.978	\$835.00	91	QCLA2031R-8-1 / 101.0201.835	\$1,040.00	45	QSLA2233-8-1 / 101.0169.275	\$830.00	42				C417P / 112.0538.950	\$100.00	97
BSL2233-9-30W / 101.0637.004	\$780.00	22	MGCM2031-9ON / 114.0643.386	\$835.00	91	QCLA2031R-8-3 / 101.0201.838	\$1,040.00	45	QSLA2233-8-3 / 101.0169.276	\$830.00	42				DBR10S / 112.0044.784	\$200.00	97
BSL2233-9-40W / 101.0637.006	\$780.00	22	MGCM2031-9PWT / 114.0637.980	\$835.00	91	QCMA1826-7-1 / 101.0203.912	\$710.00	46	QSLA2233-8-4 / 101.0169.277	\$830.00	42				EL-CLIPS / 112.0266.512	\$10.00	99
BSU1812-8 / 122.0637.635	\$620.00	16	MGCM2031-9SG / 114.0643.387	\$835.00	91	QCMA1826-7-3 / 101.0201.833	\$710.00	46	QSLF2020-10-1 / 101.0300.792	\$1,295.00	50				MB517 / 112.0624.298	\$210.00	97
BSU1816-9 / 122.0637.637	\$655.00	16	MGCM2031-9SLG / 114.0713.136	\$835.00	91	QCUA1827L-8 / 122.0202.329	\$910.00	38	QSLF2020-10-3 / 101.0293.893	\$1,295.00	50				RM55S / 112.0058.824	\$245.00	97
BSU1820-9 / 122.0637.639	\$670.00	15	MGCM2034-9CHA / 114.0637.971	\$860.00	90	QCUA1827R-8 / 122.0202.327	\$910.00	38	QSLF2020-12-1 / 101.0300.801	\$1,485.00	50						
BSU1825-9 / 122.0637.641	\$710.00	15	MGCM2034-9ES / 114.0643.389	\$860.00	90	QCUA1827R-8 / 122.0202.327	\$910.00	38	QSLF2020-12-3 / 101.0293.898	\$1,485.00	50						
BSU1831-9 / 122.0637.643	\$780.00	14	MGCM2034-9MBK / 114.0637.979	\$860.00	90	QCUA1831L-8 / 122.0202.324	\$1,015.00	38	QSU1113-6 / 122.0311.979	\$310.00	37						
BSU1832-9 / 122.0637.645	\$805.00	14	MGCM2034-9ON / 114.0643.390	\$860.00	90	QCUA1831R-8 / 122.0202.322	\$1,015.00	38	QSU1820-10 / 122.0202.337	\$770.00	52						
BSU1832-9OW / 122.0637.646	\$805.00	14	MGCM2034-9PWT / 114.0637.981	\$860.00	90	QCUA1933R-8 / 122.0170.396	\$1,085.00	37	QSU1616-6 / 122.0484.875	\$415.00	36						
BTU1841-9 / 122.0637.647	\$1,115.00	18	MGCM2034-9SG / 114.0643.391	\$860.00	90	QDL2031-8 / 101.0045.147	\$700.00	47	QSU1816-8 / 122.0202.335	\$435.00	36			</			



KINDRED-SINKWARE.COM

FRANKE KINDRED CANADA

Customer Service Department
P.O. Box 190, 1000 Franke Kindred Road
Midland, Ontario Canada L4R 4K9

Telephone 1-866-687-7465

Fax 1-800-361-8408

Email info@kindred-sinkware.com

KCATCAEN24

